

A Geologist's Responsibilities in the Aluminium Industry (Abstract)

G. Komlóssy

GEO-KOM Geological Exploration Ltd.

Budapest - Hungary

The author summarises his 40 years of experience spent in the aluminium industry working for domestic and international clients and projects.

The aluminium industry is interested in the quantity, quality and confidence of the reserves/resources in a mineral deposit and its potential, the miners in the shape, size (dimension), location of the bodies (both in horizontal and vertical terms), variance in thickness and grade, the physical parameters of the ore and host rocks (overburden and bedrock) and the investors in the possible returns and the risks involved.

All parties in the investment must be aware of the risks, that is, of the reliability of the basic data, first of all that of the resource/reserve estimate and then the related parameters.

When the industrial value of any mineral resource is judged and before a decision to invest and develop is taken, that decision takes into account further information:

- Mineability of the bauxite
- Processability of the bauxite (the ability to make economic alumina)
- Geographical position (close to users or a trade route)
- Infrastructure (accessibility, power, water, housing, communications)
- Environmental (locality, impact, local regulations and management)
- Political (basis, legality, stability)
- Cost

However, to emphasise, all of this construct and the subsequent decisions are based on the fundamental data, i.e.. the geological knowledge of the deposit and its reliability.

An understanding of the further prospect of the area is also necessary for the value of the area and a decision to develop is taken (blue sky).

The author gives an overview through the stages of the geological activities necessary to develop a bauxite deposit such as:

1. Delineation of the prospective areas
2. Prospection and exploration of the resource from the reconnaissance up to the detailed exploration.
3. Mine development exploration
4. Methods of exploration (some technical questions, drilling grid, sampling, etc)
5. Representative sampling
6. Material tests (analytical methods)
7. Reserve/resource estimate (tonnage vs. grade calculation)

As a consequence it is concluded that the geology, the mining (transport) and alumina production is one single economic unit. Criterion for economic grade bauxite can only be deduced from the technological parameters of the alumina production in order to attain an optimum for the industry in which the a geologist has to play a much larger role than it is (generally) expected.

1. Discovery of bauxite deposits

1.1. Generalities

Bauxite reserves and resources that have been revealed in the world vary between 50 billion tons of crude ore (as per 1999 – P.A. LYEW-AYEE) and 90 billion (as per 2005 – I.V. MAMEDOV). The latter figure seems to be an overestimation, probably lots of bauxite deposits were included in the inventory which do not satisfy the industrial requirements. According to the Author's estimation the total world bauxite reserves + resources could be about 60 billion tons from which 20 – 30 billion tons are identified reserves while the remainder are undiscovered resources in hypothetical and speculative categories. In spite of the fact that this huge volume theoretically may satisfy the demand of the world consumption up to 350 - 650 years - based on 140 Mt/annum world consumption and total reserves and undiscovered resources, there is an accelerated demand to find new, easily accessible deposits. The reasons are different, most frequently:

- (1) setting up new modern alumina plants of large capacity (1 – 5 million t/a) which are competitive in a large region or in the world market,
- (2) capacity of the alumina plant has been decided to be increased and no adequate quantity of reserves are available (or are not explored yet) in the vicinity,
- (3) viability of the alumina plant is not competitive enough. In order to reduce the operating costs the refinery, it has been decided to feed a better quality bauxite and for this purpose the available reserves must be increased for a better selection.
- (4) old alumina plant is running out of its existing (licensed) reserves..

ad (1). A refinery is planned to be set up either close to the mine, or bauxite is planned to be supplied from a long distance to the plant. In the first case the analyses of the transport cost between the plant and source is entirely an economic question but in the second case the geologist has to select among the given possibilities, so that:

- (a) It is necessary to clarify whether there is any prospective area between the plant (along the existing transport route) and the already discovered and explored deposits.
- (b) Exploration program of already discovered (reconnaissanced) deposit(s) should be managed in such a manner that the deposits - which are situated in the best position - have to be taken in preference. .

There are huge bauxite deposits in the world which can not be economic at the present time because of the missing infrastructure (e.g. Surinam (Bakhius Mts., Mali, Bissau, Guinea, Vietnam, etc.). In the recent situation the alumina projects are not able to cover the costs of significant development of infrastructure. In those countries, or regions, where bauxite has been found in abundant quantity not all of the already discovered bauxite deposits have to be explored in detail, but bauxite prospecting should be focused to those areas where infrastructure is available and the area has not been investigated adequately for bauxite. (e.g. Guinea, India). In the utilisation of the *Trombetas* bauxite (Brazil) and *Los Pijiguaos* (Venezuela) the existing natural transport routes (Rio Negro - Amazon and Orinoco rivers resp.) played an important role. Other deposits became important because of their close location to a deepwater port.

It may also happen that the development of the infrastructure is financed by the state making viable by this way, the establishment of the bauxite – alumina – aluminium industry (as it is planned e.g. in Saudi Arabia for the Az Zabirah deposit.). The utilisation of the South Vietnamese bauxite deposits was abandoned in the late eighties because the State dropped the idea of the construction a railway track between Ho Chi Minh City (Saigon) and Phnom Penh (Cambodia).

ad 2,3,4 There is no difficulty provided the owner of the refinery has a long-term project and the further prospects of the surroundings are clarified at least in a reconnaissance stage. Nevertheless, it is worth mentioning that the decision making for increasing the plant capacity or increasing the grade of the bauxite to be used in the plant may come easily and fast and the geologists are urged to provide for bauxite immediately. According to the Author's experience the decisions are not always well prepared geologically. In these cases such solutions are forced and – because of the inadequate geological preparation – may result in industry losses For example when bauxite is transported to the plant from a much longer distance than all accounts would be necessary. For example the BALCO (India) supplies bauxite to its Korba plant from about 250 km (on road by track) without investigating the area in between the known deposits and the plant.

1.2. Identification of new deposits and delineation of prospective areas

Bauxite deposits have been discovered so far, from the historical point of view, may be classified into three main groups:

- Deposits discovered by chance (during some agricultural or construction activities)
- Deposits discovered by general geological mapping, aerial photograph interpretations or prospecting for some other raw material,
- Deposits discovered for the sake of finding new deposits

Detailed investigation of the history of bauxite discoveries belongs to the scope of the “history of sciences”. Bauxite target oriented prospecting has shared a more and more important role at the time.

The bases of identification of new deposits are:

- increasing reliable and relevant geological knowledge about bauxite formation,
- application of the principles of analogies in subsequent steps and range in which the approach is as follows:
 - (1) *general geological analogies*: stratigraphy (stratigraphical gaps) lithology, paleogeography, tectonic pattern, etc., for karst bauxites and climate and parent rock for the laterite bauxites.
 - (2) *bauxite geological analogies* (morphology and drainage conditions for laterite bauxite
 - (3) *deposit analogies* (mineralogy, size, shape, orientation, thickness of the ore body) for both karst and laterite types.

The range of application of analogies can be very narrow: from some km (within one deposit or group of the deposits) or some tens of km in distance (e.g. applied in the Dinarids – Croatia – Bosnia-Herzegovina or in the Bakony Mts. Hungary) but sometimes the analogies are extended far from the known deposits (applied e.g. in the Mediterranean bauxite belt) or even in a longer distance, their application may bridge continents (India – Africa – South America – that is, applied to the ancient Gondwana continent).

Delineation of the prospective areas, in the case of karst bauxite, is restricted practically to the delineation of the possible stratigraphical gap(s) and lithofacies of the bedrock and immediate covers where the expected depth of the deposit is also important. In the following, (in this Chapter) the emphasis is put on the laterite bauxites because the main developments in the aluminium industry are expected to relate to this type of ore.

Delineation of potential areas of laterite bauxites, provided they are not covered by younger sediments, can basically be based on:

- (a) parent rock ,
- (b) morphology,
- (c) absolute elevation,
- (d) vegetation.

for these purposes:

- geological and topographic maps in different scales (from 1:25,000 to max. 1:100,000),
- radar photos (Digital Elevation Models – (DEM), Shuttle Radar Topographic Mission (SRTM).
- Landsat TM images (752, 457, 453) can be used.

Channel combination must be fitted to the local conditions. In case of adequate bauxite geological knowledge and favourable geo-morphological conditions bauxite contours can be identified within a maximum error of 100 m. (G. KOMLÓSSY – Z. UNGER, 2004, G. KOMLÓSSY 2006)

It is also essential to be aware of the type of the deposit expected to be found. Based on the morphology bauxite deposits can be classified into:

(1) *Plateau type* where bauxite accumulated on flat (sub)horizontal, or moderately inclined or slightly undulating surfaces and pinches out at the rim of the plateau. When the rim of the plateau is a sharp one (e.g. Deccan bauxites in India, Kindia in Guinea) ore body contours are well definable outlines. (**Photo 1.**) . In some cases the rim of the plateau is defined by slopes and the bauxite pinches out at inclination between 15° and 20° as at Los Pijiguaos – Venezuela, and between 5° and 15° at the East Coast bauxites - India. The grade of slopes can be correctly measured on landsat maps applying SRTM. See **Fig. 1.**

When the surface is an undulating one and bauxite developed in lenses restricted to mounds (with relative elevation of about some 10 metres) the contours can also be well detected after some field experience (Lichenya plateau in Malawi (**Photo 2**), Bao Lok in Vietnam, etc.

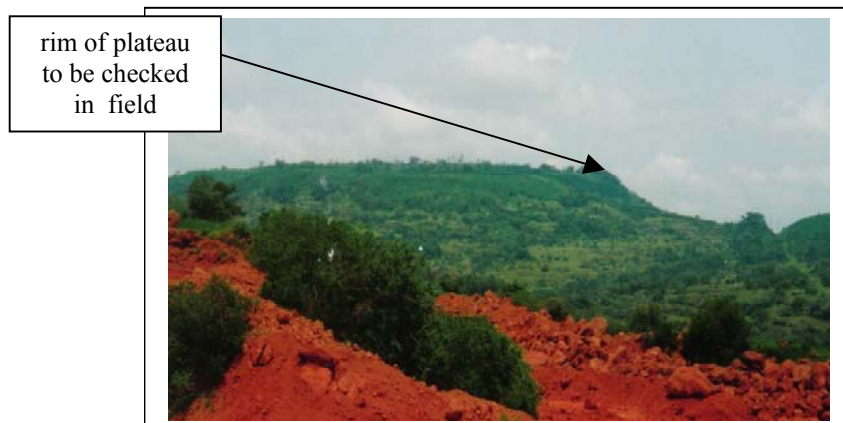

Photo 1.

**Plateau locating west
of NW Block XII
Kindia - Guinea**

Photo 2.
Lichenya plateau
Malawi

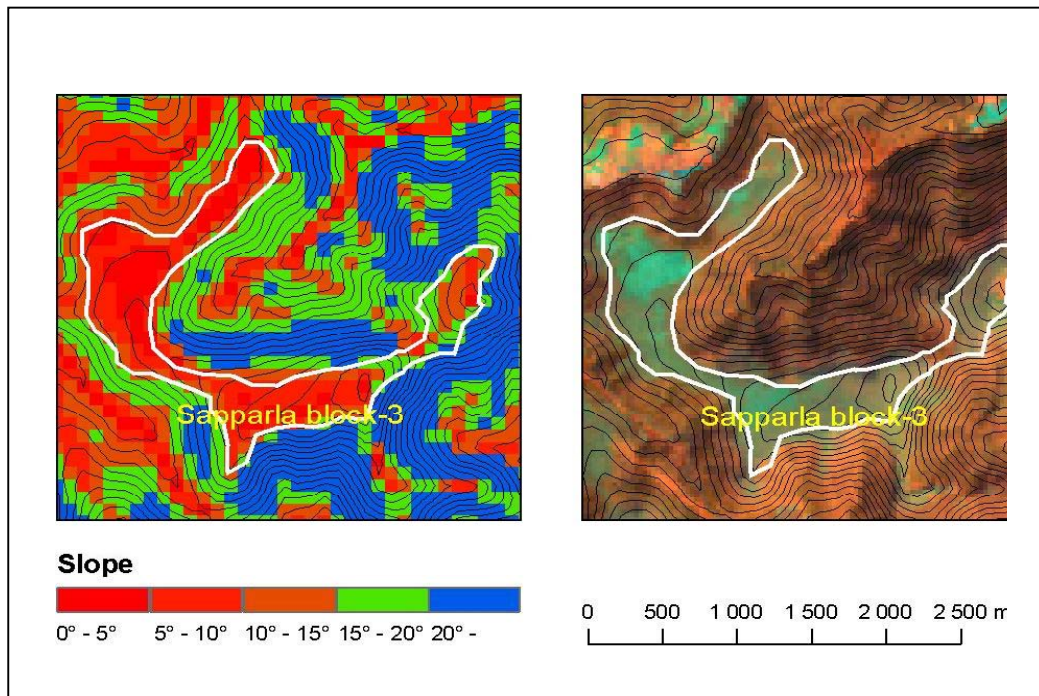

Fig. 1.
Slope and TM 453 maps of the Sapparla Deposit – AP India

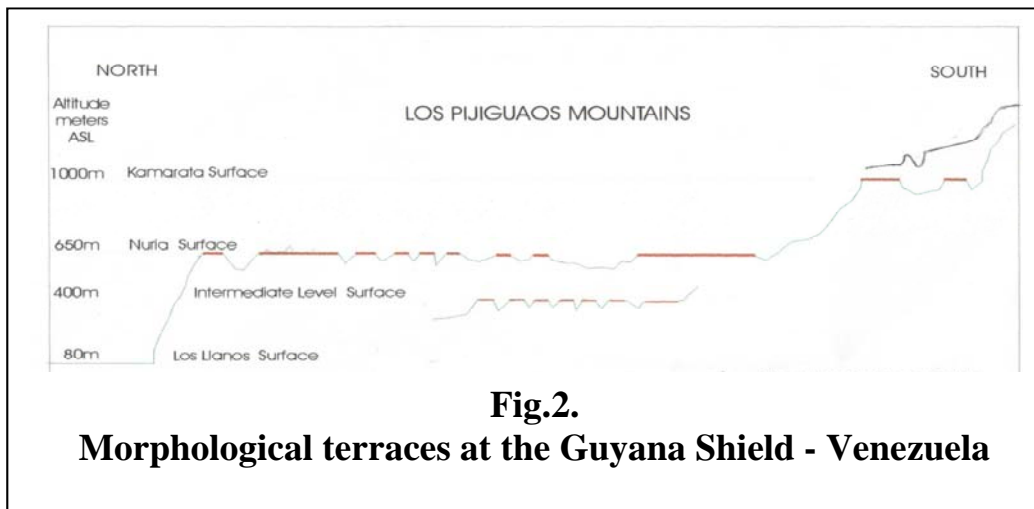

Fig.2.
Morphological terraces at the Guyana Shield - Venezuela

after
A. MENENDEZ
AND
A. SARMENTO
1982

Ore bodies of plateau bauxites may be related to:

- (a) *one single plateau surface*: such as: Deccan bauxite in Central India, Boké, Kindia, Fria in Guinea , Bao Loc in Vietnam, etc.,
- (b) *multiple, morphological terraces*: series of planation surfaces of different ages in broad range of elevation. Guyana They are typical at the Shield in Venezuela - between 400 m and 1000m asl – see **Fig. 2.** and at East Coast bauxites in India - between 900m and 1450m.

(2). *Slope type deposits*: there are laterite bauxite deposits accumulated along the slopes of hills or ridges where the inclination may reach 23 – 30 degrees (Darling Range – Western Australia) (See **Fig. 3.**)

(3) *Dome and slope deposits*: Fongo Tongo - Cameroon. (**Fig. 4.**)



Photos 3. and 4.
Whale back plateaux at Los Pijiguaos - Venezuela

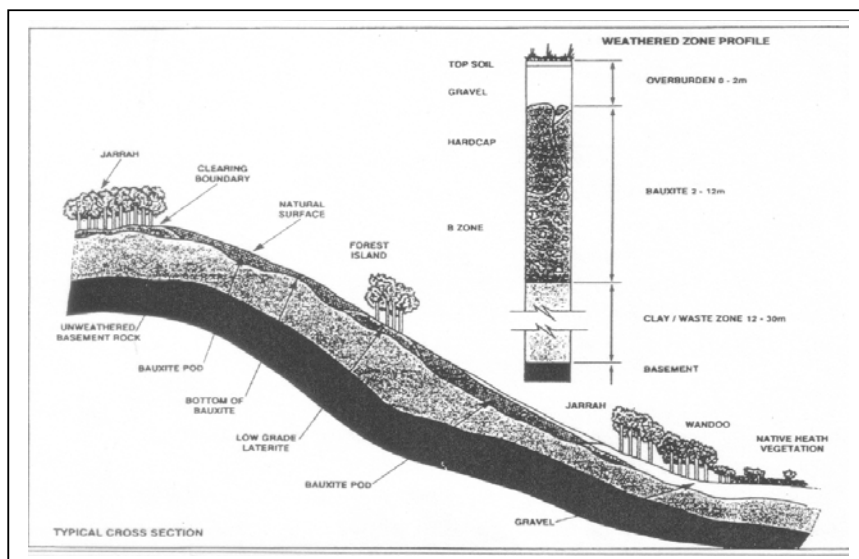

Fig. 3.

**Slope type deposit –
Darling Range (WA)**

Source: Worsley document 1993

Topographical maps of 1:100,000 scale can only be applied in the delimitation of prospective areas provided the topography is not very abrupt and where large and quasi flat planation surfaces have been formed (e.g. in Guinea) in other cases, topographical maps must be available for this purpose in a scale of minimum 1:50,000 (e.g. India Deccan bauxites). Where the topography is very dissected and no large and flat planation surfaces formed or where the bauxite is common on the mounds, the minimum scale for ore body delineation is 1:25,000 (e.g. Los Pijiguas – Venezuela) and 1:10,000 (e.g. Bao Lok Vietnam, Lichenya – Malawi).

**Slope – dome like
deposit
at Fongo Tongo
(Cameroon)**

Fig.4.

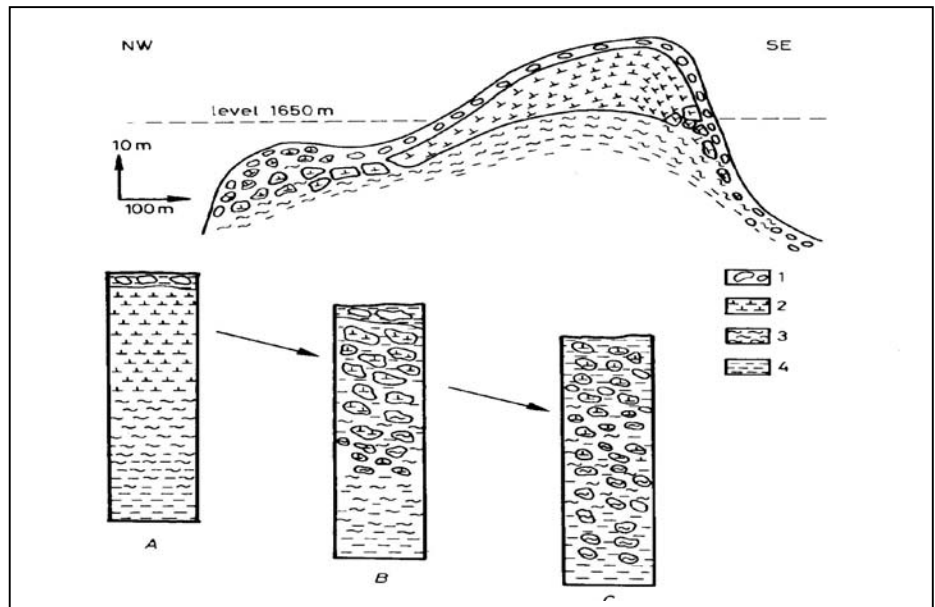

Legend: 1. Duricrust partially disintegrated, 2. Hardened bauxite on the top of the hill, 3. Bauxite, 4. Saprolite. (after: HYERONIMUS, 1985)

1.3. Reconnaissance

Identification of bauxite deposits based on morphology, elevation, parent rock, vegetation, must always be checked on the field. It may occur that in the same morphological pattern, on similar topographical level on the same parent rock – even side by side – a plateau is productive while the other one is absolutely barren. This phenomenon due to the different physical property of the parent rocks resulting in considerably different drainage conditions. Hence the escarpments must be checked, sampled and analysed. If bauxite has been verified at the rim of the plateau the escarpment should be surveyed, by walking around and being measured by GPS. Using portable auger drilling equipment is highly recommended to make some randomly spaced holes inside the plateaux, because it also may occur that there is no bauxitisation inside the plateau.

When the plateaux are proven to be productive, selection should be made based on the function of the expected:

- quantity and quality (processability),
- mineability and
- accessibility of each ore body or groups of the ore bodies (haulage cost)

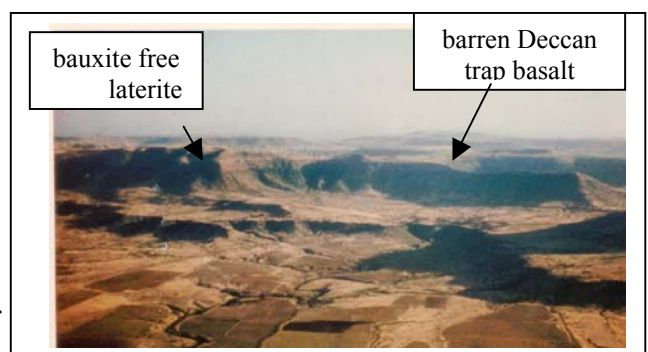

**Western Ghats – Maharashtra – India
Photo 5.**

By this way deposits (group of the ore bodies) can be ranked in their economic values and preferences given in planning and itemising of the exploration and mining accordingly, beginning the mining operation of the deposits which provide the highest possible profit.

2. Bauxite exploration

2.1. Exploration methods.

The basis of the reliability of the reserve calculation/resource estimate is the correctly applied techniques in the exploration (see details under **Paragraph 2.1.3.**). When the value of a proposed bauxite/alumina industry is checked by an auditor or when a “Competent Person Report” is made special attention should be paid to this critical topic.

2.1.1. Trenching

In case of outcrops or near surface deposits – mainly in the reconnaissance phase – trenching is used for clarifying the bauxite thickness, lithology, grade (also mineralogy), dip and strike of bauxite. Trenches can be one metre in width and several ten metres long. Trenches are mapped in scales of 1:100 to 1:500. Geological sketches are made of the trenches, the sampling intervals and the grade of bauxite.

2.1.2. Pitting and beneficiation.

Advantage: most reliable sampling (provided it is correctly done, see later).

Disadvantages: time consuming and expensive even in case of low labour cost.

There are several cases when non other then pitting is the only method applied in the exploration e.g. at Mulanje Mts. (Malawi) because of the topographical difficulties no drilling machine can be carried up the mountain, or when the drilling does not provide representative samples. The latter case is typical when relatively hard industrial grade bauxite (sand, nodules, gravel, boulders) are cemented by soft low grade bauxite or clay. In such cases beneficiation is necessary. Selection can be made either manually during the mine operation (e.g. Balco and Halco mines in India) or by mechanised dry or wet screening. The latter procedure was used in Vietnam both for the young laterite bauxite (Southern Vietnam) and for the paleozoic karst bauxite deposits (Northern Vietnam) Bauxite upgrading, by applying scrubbing wet screening and hydrocyclones, is known to be very efficient for the Trombetas (Brazil) deposits.

Measuring of pit volume

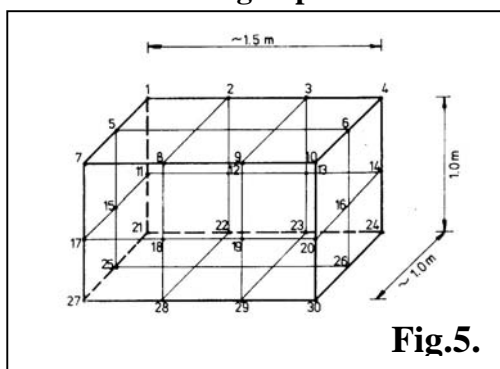
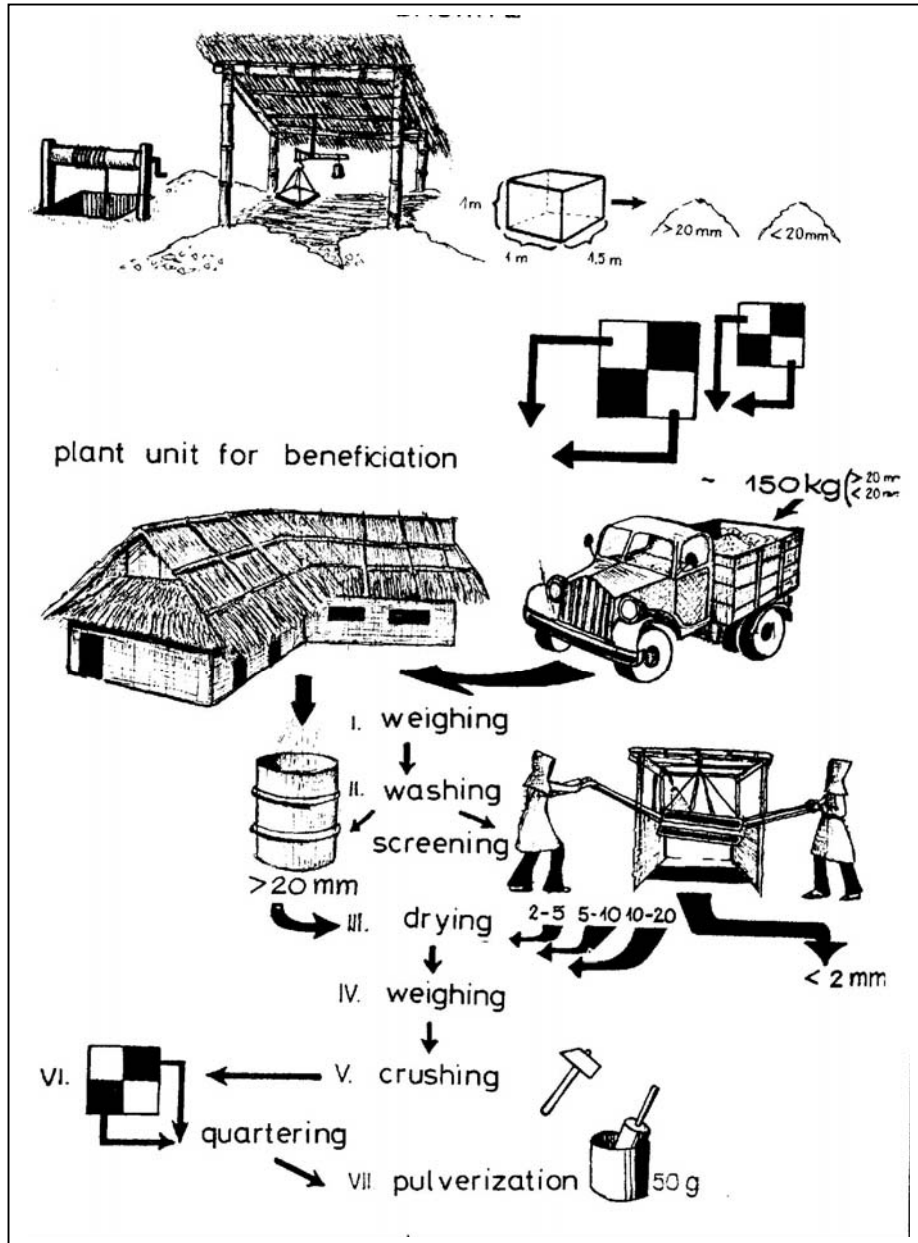

Fig.5.

When any beneficiation method is used, no channel sampling is recommended, but only sampling of the total material excavated from each interval of the pit. It is necessary to measure the volume and weight of the raw bauxite extracted in each interval, as it is shown in **Fig 5.** By weighing of the beneficiated material (concentrate) the recovery can be calculated and recorded in % or tons/m³.

Bauxite sampling and sample beneficiation

Lang Son – Northern Vietnam 1972 – 1975



Drawn by : A. MINDSZENTY 1975

Fig. 6.

2.1.3. Drilling

Core drilling (CD) and recovery

Drilling is widespread all over the world. Most deposits have been explored in this way. It is a reliable method, provided the sample is not beneficiated. In the last decades the technology was developed a lot. Nowadays, use of double-walled bits, wire-line method and moreover triple-walled bit technologies are known. Using diamond technique (nearly)100 % recovery is often attained.

It is recommended to require (as a general rule) that not less than 70% of core recovery for any one m interval, 80% for the whole penetrated section and 90% for deposit average. Thanks to the advances in drilling technology the average core recovery has considerably been increased, therefore the input data of the reserve calculation became much more reliable in the last decades.

Diameter of cores must be NQ (52mm) minimum. Both in the laterite and karst bauxites bits of HQ (63mm) is preferred. When the bauxite is very hard (rigid) and heterogeneous in hardness, PQ(84mm) is recommended to apply.

Flushing medium: application of clean water or different polymers are recommended.

Non-core drilling

(1) *Auger drilling:* Where physical properties of the bauxite allow to the use of an auger it is an acceptable method, however, its reliability is far behind that of the diamond core drilling. The biggest possible errors in quality should be taken into account when reserves/resources are categorised. Let us consider the following example:

In Guinea samples were taken for technological purposes and auger bore holes drilled at the close vicinity of previous exploration holes. The alumina and silica contents were compared in the identical intervals of the twin bore holes. Remarkable deviations were revealed as they are shown in **Fig 7** and **Fig 8**.

Bias in alumina and silica content in an auger (A) and auger(B) twin hole (Guinea)

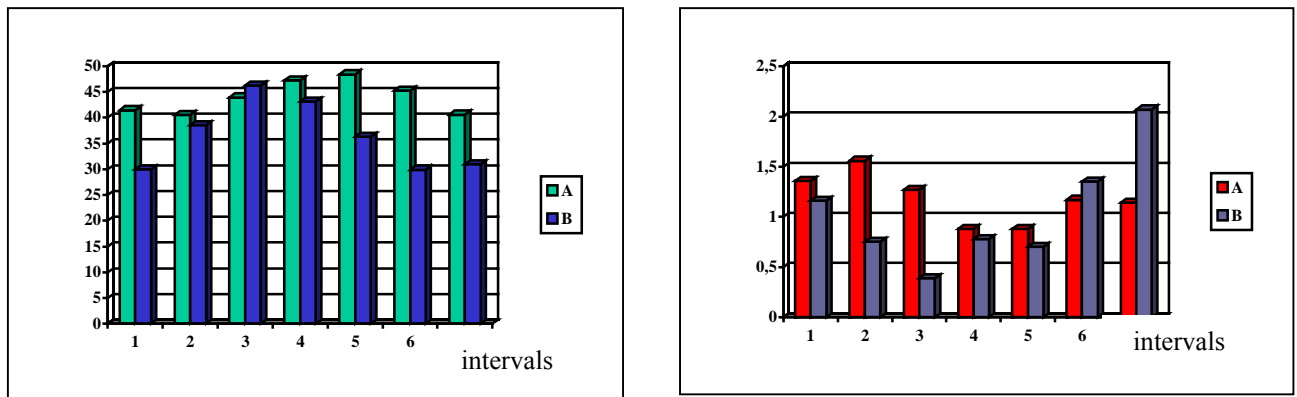

Fig. 7.

Distribution of deviations in alumina content auger - auger twins (225 pairs) Guinea

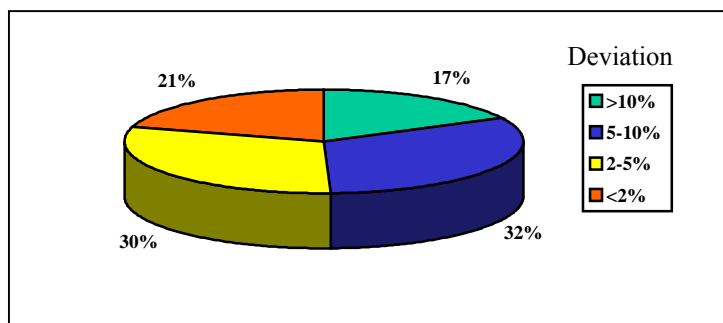

Fig. 8.

Bias in Al_2O_3 % was bigger than 5 abs.% in almost half of the samples. In such cases the reserves can hardly be assigned to the measured (proven) category even if the bore holes are spaced in 50m x 50m grid.

In order to avoid the discrepancies described above the following procedure is proposed :

- At the beginning of the exploration campaign it is recommended to check the reliability of the auger technique by several randomly spaced pits. If the biases in alumina and in silica contents are acceptable (for alumina max. +/-2 abs. % in interval basis and max +/-1% for total thickness, for silica max. +/-1 % in interval basis max. +/-0.5% in the total thickness) the auger techniques may be accepted. If the deviations are bigger the following solution may help:
- Bauxite sample must be weighed and one has to try and ensure that the same quantity of material is taken from each 1 meter interval.
- When bauxite quantity drops it is necessary to pour some water into the hole, making the bauxite wet in order to ensure better sample recovery.

Auger drilling in Guinea

When the *Sangaredi* and *Bidikum* (Guinea) deposits were explored both core and auger drills were used. The problem with the combined method is that the data - derived from different methods - are not consistent, namely, in case of core drilling the possible error is less than in that of the auger drilling. It is an important rule that **in the reserve calculation consistent data must be used**, otherwise, it is not possible to estimate the possible error and compute the variance for alumina, silica contents and thickness.

If these methods do not lead to an acceptable result, no auger techniques should be used. If the auger method has been proved to be correct in one deposit (e.g. Bidikum) it does not mean that it may also be applicable in another one (e.g. Kindia). The reason is that *the applicability of the auger depends on the physical parameters of the bauxite which may be different in different deposits.*

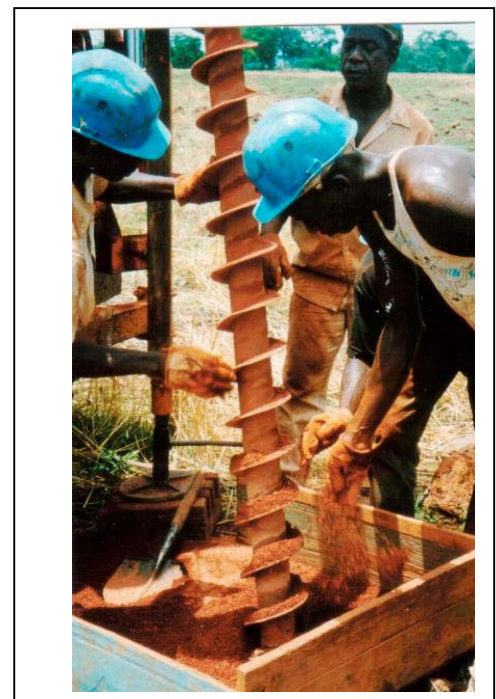

Photo 6.

(2) *Vacuum drilling*.. It is a very efficient and acceptable method provided the bauxite is homogenous in its physical properties. This method was applied at the Worsley mine - Darling Range - Western Australia - and it has been proved to be reliable when exploration data (forecast) are compared with those of subsequent mining (actual). This type of bauxite is loose, friable and quasi homogenous. Encouraged by the success this equipment was also applied for the Indian Daccan bauxite which is quite different

as it is composed of hard bauxite boulders and soft clayey matrix. In such a case this method is absolutely inconvenient as the soft clay and hard bauxite are mixed by drilling and nothing can be known about the quantity and quality of the ore to be extracted, but an average of the bauxitic complex. are not of the manually selected hard bauxite.

Vacuum flush drilling at Jamirapat Chattisgarh State - India

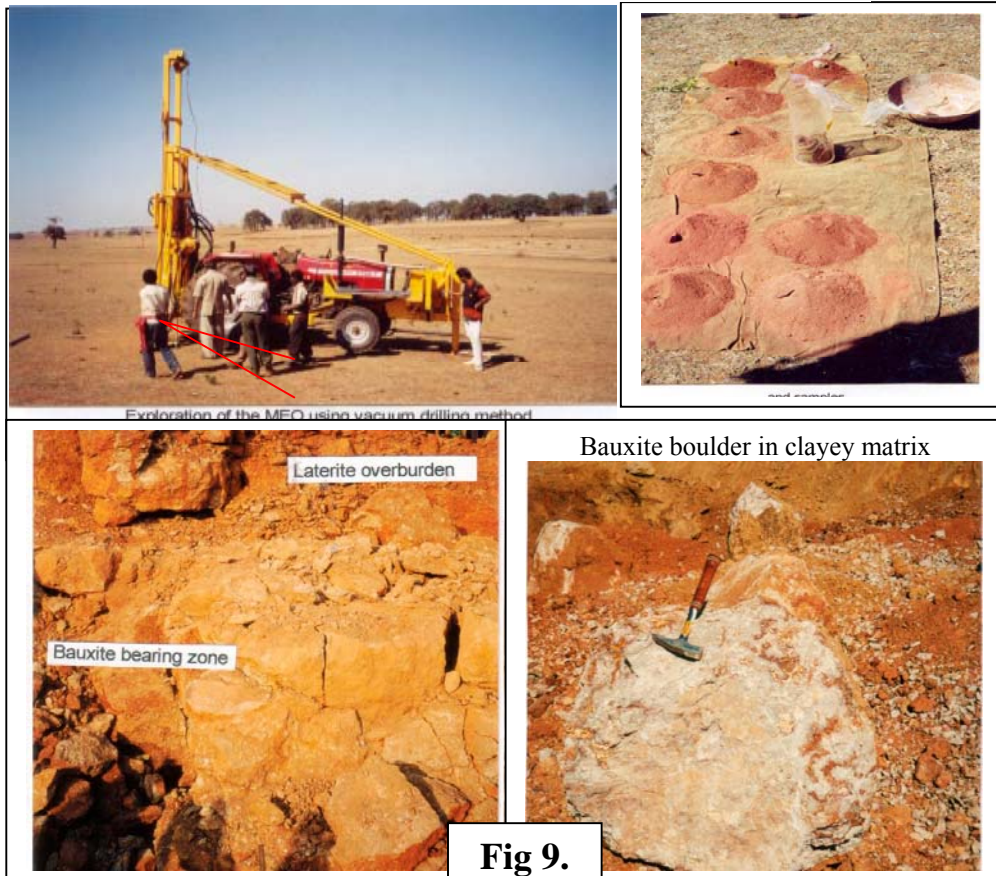
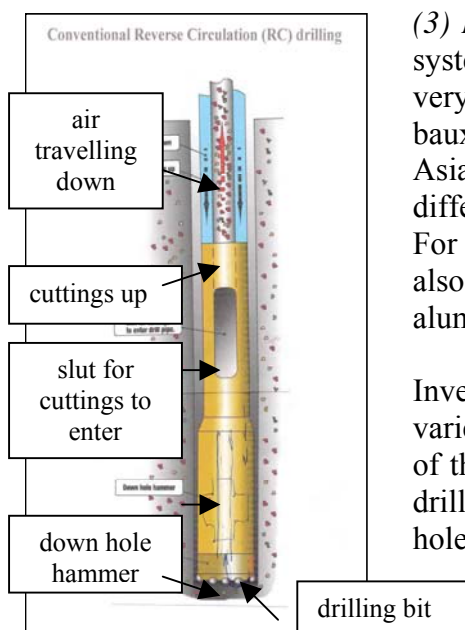

Fig 9.



(3) *Reversed circulation (RC) air flush drilling.* The operation system of this method is shown in **Fig. 10 and Photo 7 and 8.** A very hard, brecciated, (pseudo)conglomerated pisolitic laterite bauxite of Upper Cretaceous age was drilled by this method in an Asian country. The bauxite was very heterogeneous: the different textural elements were very different in their quality. For checking purposes of this method diamond drillings were also made in the close vicinity of RC drillings. The bias in alumina and silica content is shown in **Figs 11. and 12.**

Investigation of 280 RC bore holes revealed that the recovery varied between 40% and 140%. It was also revealed that the rate of the recovery increased by depth. It indicates that during the drilling operation more and more material falls back into the hole and more and more (mixed) material was obtained.

Fig. 10.

As a conclusion it is to be established that the RC drilling, even if it has been proved to be reliable in Australia, can not be applied everywhere., mainly if the bauxite is heterogeneous in its physical properties.

RC drilling and sample (cuts) logging



Photos 7. and 8.

Bias in alumina and silica contents in a DC (A) and RC (B) twin drilling

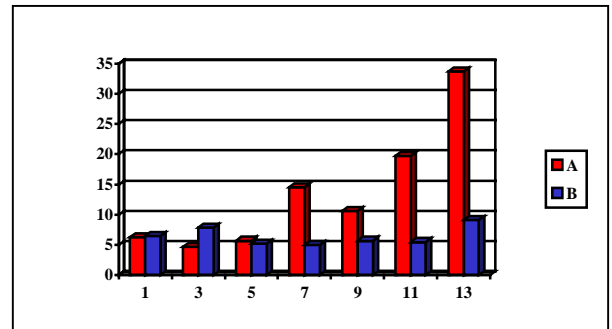
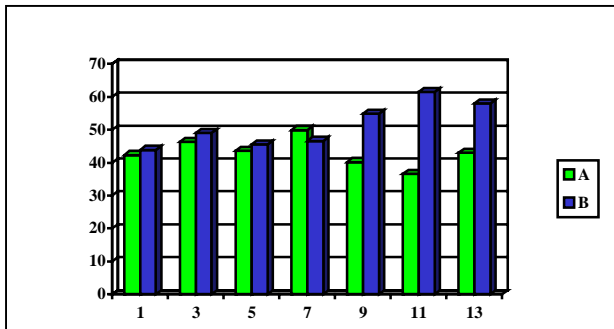
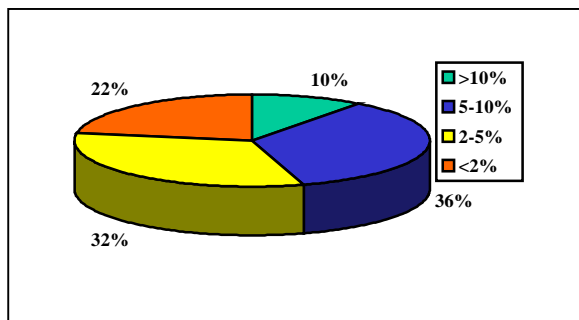

Fig 11.

Distribution of the deviations in alumina and silica contents in DC -RC twins in 219 pairs

Al₂O₂ %



SiO₂ %

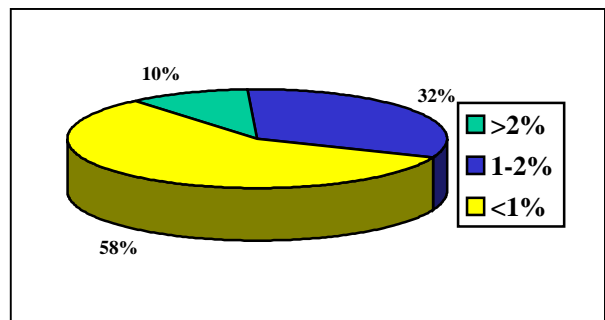

Fig. 12.

2.1.4 Financial considerations - Let a geologist think

Conditions: 1 m core (diamond) drilling: 80 USD/m

1 m non core drilling.....: 20USD/m

In case of a laterite bauxite let us calculate 3 m bauxite and 1m + 1m for overburden and bedrock:

5 m core drilling.....400 USD

5 m non core drilling ... 100 USD

applying 100 x 100m grid (detailed exploration) it results in 69,000 tons of bauxite.

Drilling of 1 ton of bauxite by core drilling.....0.00579 USD/ton

Drilling of 1 ton of bauxite by non core drilling.....0.00145 USD/ton

Let us suppose:

Bauxite price at plant..... 15 USD/ton bauxite

Bauxite price in the alumina.....: 20%

Specific bauxite consumption:..... 2.5 ton bx/alumina.

In this example:

Bauxite exploration cost for 1 ton of alumina

core drilling:..... 0.0145 USD

non core drilling:...0.0036 USD

In % of alumina production

core drilling.....0.0725%

non core drilling....0.0181%

Whether it is worth saving money on exploration ?

Whether it is worth undertaking an absolutely unnecessary risk caused by non reliable geological data obtained by non core drilling?

2.2. Orientation and spacing of drilling/pitting grid.

2.2.1. Orientation of the drilling/pitting grid.

The drilling/pitting grid must be fitted to the orientation of the ore body. Where the ore body is covered the expected orientation of the deposit can be predicted by the main structural pattern.

In case of the karst bauxite, as the process of the karstification itself (including the drainage) is also controlled by the pre-existing fault zones, the shape of the buried deposit can also be established prior to the exploration start. See Figs **13 and 14**.

**Location of covered bauxite lens
a star
Nyirád: Izamajor -**

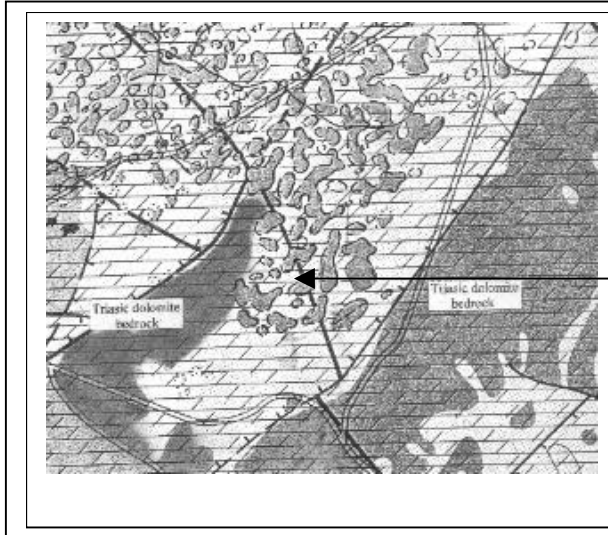

F

**In the Timan bauxite district (Russia:
structu**

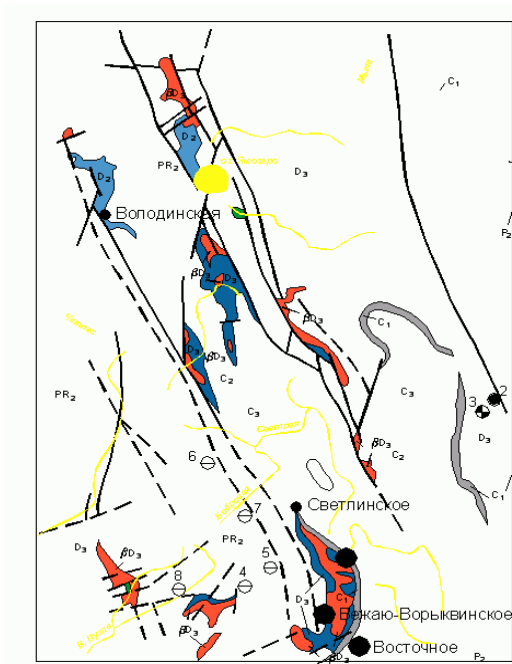

Fig. 14

ain

Also in case of the laterite bauxites the shape of the ore deposit is determined by the prominent structural lines as a consequence of the tectonics. When the shape and orientation of the possibly productive areas are well defined, as is shown in **Fig.15.**, the orientation of the grid should be fitted accordingly.

Elongated ore bodies and recommended orientation of the drilling grid (Khuria Highland – Chattisgarh State – India)

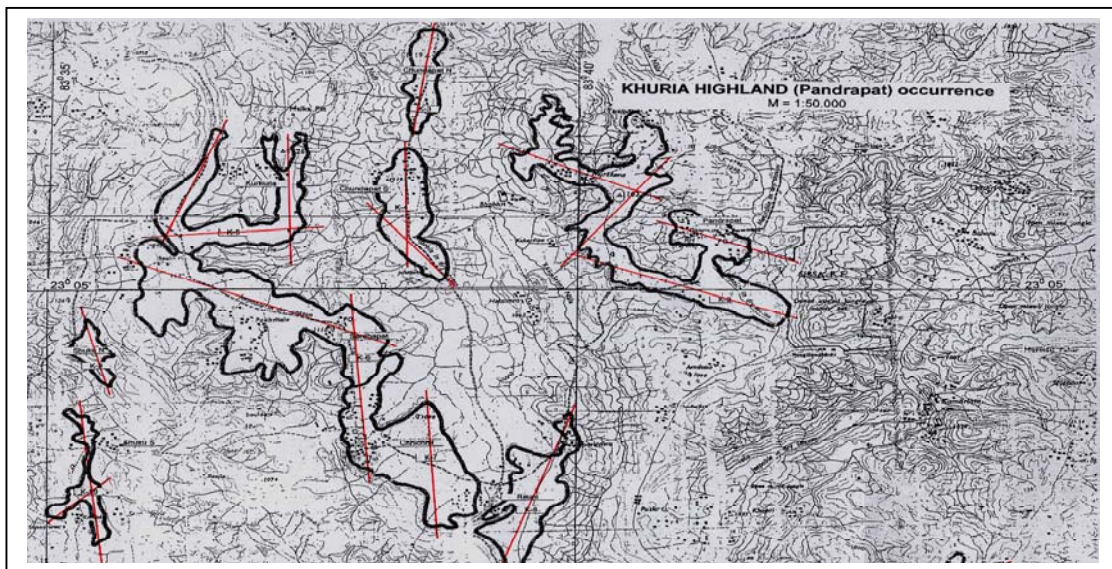

Fig. 15.

Where the ore bodies do not show elongated forms and there are no privileged directions the grid orientation has no significance.

2.2.2 Bore hole – pit spacing

Drilling and pitting must be located in such density that at the end of the exploration reliable data be available for the general mine planning in long- and short term basis.

What is the reliable datum ?

Data are reliable provided the errors in all of the measured parameters (thickness, grade, depth, dip, etc) can be kept within such a range that the extraction can reliably be planned for long and short term, in a way that, under the given geological conditions, maximum profit can be attained (the possible maximum tonnage - minimum loss with the best possible grade – minimum dilution on a cheapest way). For mining plan data are gained from the *mine development exploration* (**Chapter 5.**). Reliability of the geological information, including the number of measured data, depends - beyond the techniques used in drilling (2.1.3) - on the density of the drilling/pitting grid.

It is a general rule that any data which are extrapolated in any direction must be consistent bearing the same range in possible error in the same distance.

Apart from rather unusual geological conditions such as Severuralsk – Russia where the point of the penetration of the bauxite can not be determined in advance because of the significant bore hole inclination at big depth (600m – 1,200m) regular grids are applied and developed in *square* or *oblong* arrangement.

(1) Square grid:

Its application is acceptable if there is no privileged direction(s) along which the variance of the most important elements of the parameters do not depend on any direction. It means that the ore body is *quasi isotropic in horizontal term*. Such a case does not exist in karst bauxites, unless the bauxite accumulated in a simple and single sink hole but may occur in case of laterite bauxites where the ore body is in a large mantle non-elongated, but in a rounded-like form such as e.g. Shinthiourou and Bidikum in Guinea, Trombetas in Brazil, etc.

The isotropic characters of the bauxite can be derived from the drainage intensity when it does not depend on any direction. This geological phenomenon is provoked by

- relative tectonic tranquillity for a long period and
- the physical nature of the parent rock such as e.g. non-orogenic granites, other intrusive rocks, schists, sandstone of marine origin, etc.

The spacing of the bore holes/pits in the stage of reconnaissance is dependent on the drilling grid decided to apply in the stage of detailed exploration. Two versions are common:

(a) reconnaissance commenced in 300m x 300m or 600m x 600m and detailed exploration completed in 75m x 75m or 37.5m x 37.5m (**Fig. 16**).

(b) reconnaissance commenced in 400m x 400m and exploration finished 50m x 50m in the detailed stage.

It is to be mentioned that in the overwhelming majority regular grids are unfortunately applied in spite of the fact that ore bodies are mainly anisotropic in their inner structure.

ALCAN square grid applied at Bidikum deposit (Guinea)

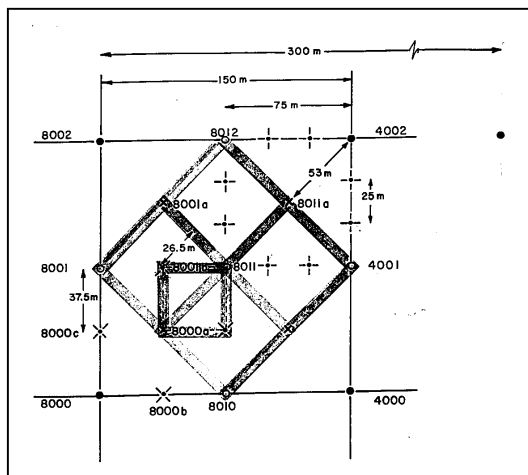
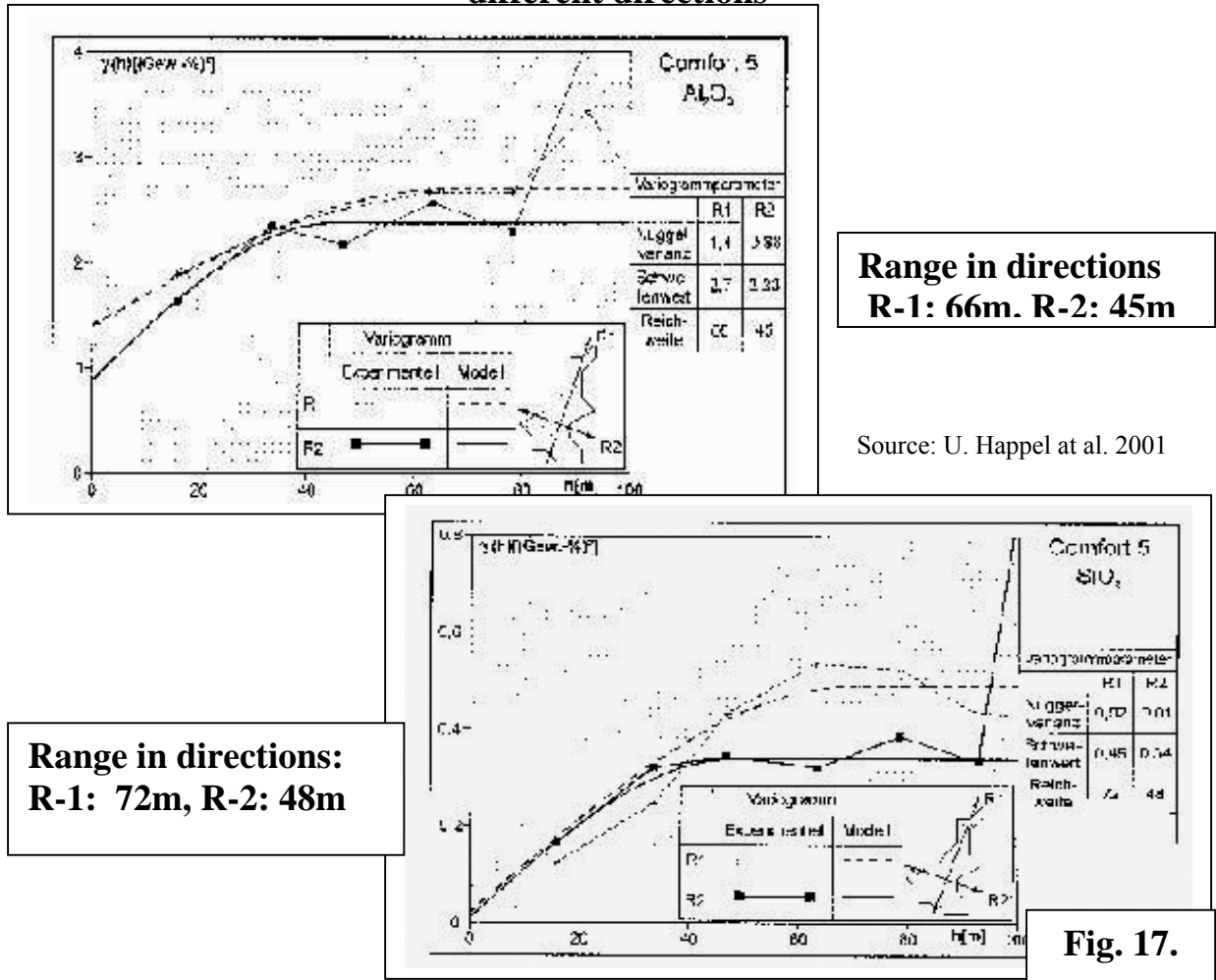

Fig. 16.

(2) Oblong rectangle grids

The anisotropy, in our case, means that the geological parameters measured in a point can not be extended in any direction with the same confidence level, that is the range of the variance of grade and thickness depends on direction as it is shown in **Figs 17 and 18**. Semi-variograms computed along in different directions show the range of variances of the most important parameters ranking along an ellipse **Fig. 18**. The ratio of the major and minor axis called *modulus of the anisotropy* may be used in establishing the longer and shorter side of the rectangle oblong as it is also on the **Figs. 18 and 19**.

Semi-variograms of Al₂O₃ and SiO₂ values showing different ranges in different directions



Source: U. Happel et al. 2001

Fig. 17.

Semi-variograms of thickness computed along four directions Csabpuszta – Hungary

source: B. FODOR, 1983

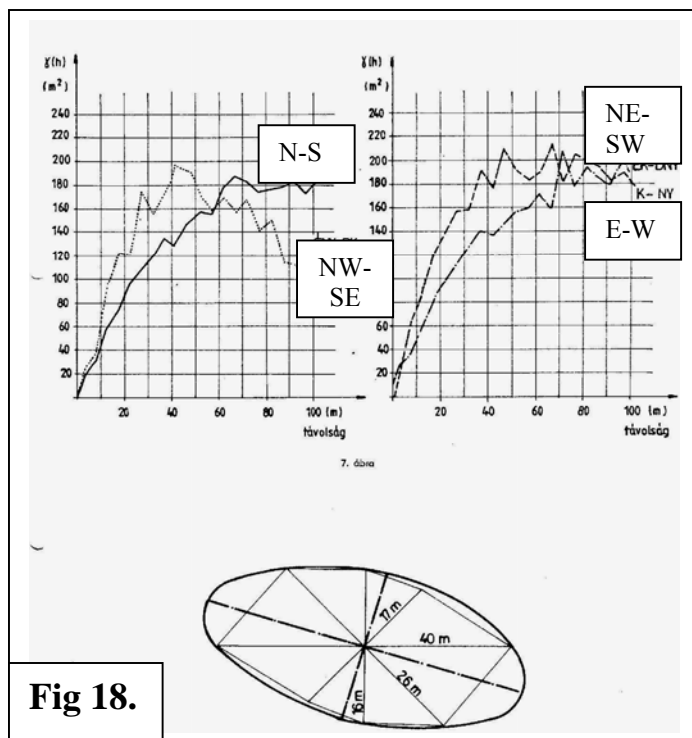

Fig 18.

Ellipse of iso-variance lines are covered better by an oblong rectangle grid

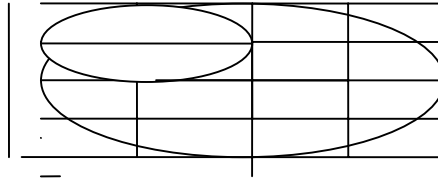

Fig. 19.

Optimum spacing of the grid is determined by the following factors:

- (1) size of the ore body,
- (2) shape (orientation) of the ore body,
- (3) depth of the ore body.
- (4) anisotropy of the main parameters.

Each bauxite deposit (single ore body or group of ore bodies) has its own nature. Not only the orientation of the grid but also the spacing of the bore holes must be fitted to it.

As a guideline the following drilling grids are recommended to apply for detailed exploration dedicated to satisfy the demand of the long- and short-term (minimum one year) mine planning. For short term plans the following conditions are deemed to be followed in the case of laterite bauxites:

Maximum error (95% confidence level) are:

- for tonnage: +/- 10%
- for alumina: +/- 10%
- for silica: +/- 20%

For karst bauxites for tonnage +/- 20% error is also acceptable.

Error in contaminants of accessory elements such as C^{org} , ΣS , carbonates of Ca, Mg and P_2O_5 are out of consideration because their concentration always varies extremely. Distribution of these elements can only be clarified by the *mine development exploration or better by regular grade control* during mining

Guideline for bore hole/pit spacing in detailed exploration

Table 1.

type/size in ha	non-oriented shape	oriented shape
Laterite:		
>100	200m x 200m ¹ 150m x 150m, 100m x 100m	100m x 150m, 100m x 75m,
<100	70m x 70m, 50m x 50m	75m x 50m
Karst		
>100	100m x 100m/70mx70m	100m x 70m, 70m x 50m
<100	33m x 33m	50m x 50m, 50m x 33m

¹ At the Trombetas mine 200m x 200m grid was applied and verified to be reliable to classify the bauxite into proved (measured) category.

It is obvious that delimitation of the rim of the deposits needs closer spacing of bore holes than the inner part. It is the same for those deposits where in the inner part, barren “islands” or bedrock outcrops can be found on the surface (e.g. East Coast bauxites Orissa – India).

2.2.3 Determination of the drilling grid for detailed exploration.

Apart from the guideline, summarised in the **Table 1**, for the establishing of the optimum detailed grid (by which reserves of measured category can be gained) there are two empirical methods:

(1) Subsequent reserve calculations (direct method)

This method is recommended when new deposit(s) is/are discovered and there are no data for the variance of parameters in the close vicinity which can be used as an analogous pattern for establishing the drilling grid to be applied in the stage of detailed exploration

As the exploration is going ahead from the reconnaissance stage (600m x 600m, 400m x 400m) reserve (resource) calculations should be made at the end of each subsequent stage of the exploration. As the infill drillings are performed the modification of the reserves should be checked with re-estimation carried out step by step. When there is no more significant change in tonnage, in alumina (or in available alumina) and silica (or in reactive silica) contents, the exploration is completed, because by further decreasing of space distance no new relevant information can be gained and error can be kept within an acceptable range (Paragraph 2.2.1.). In the explorations conducted at the Timan (Russia) deposits this principle was adapted correctly.

It is worth mentioning that according to the experiences of the author several laterite deposits are over explored.

(b) Cross validation (indirect method)

When an ore body, or a group of the ore bodies are explored in detail applying a grid of closely spaced drill holes calculation can be made for the main parameters and check how the parameters are changing when every second bore hole is dropped from the calculation step by step. For this purpose an attempt was made by the author for one of the ore bodies of the Kindia (Guinea) deposit as it is shown in **Table 2**

Table 2.
Change of the expected parameters with increased bore hole spacing

Section	Parameters	25m intervals		50m intervals		75m intervals		100m intervals	
		N	EV	N	EV	N	EV	N	EV
A	thickness(m)	17	4.35	8	3.88	6	4.00	4	3.75
	Al ₂ O ₃ %		45.57		46.27		48.04		44.78
	SiO ₂ %		2.23		2.08		2.10		2.08
B	thickness(m)	22	4.73	11	4.73	8	4.88	6	4.17
	Al ₂ O ₃ %		45.77		45.38		45.40		45.48
	SiO ₂ %		1.97		2.00		2.05		2.18
C	thickness(m)	38	4.74	19	4.90	13	4.85	10	5.10
	Al ₂ O ₃ %		45.73		45.86		45.75		46.44
	SiO ₂ %		1.97		2.08		1.84		2.01
For A+B+ C	thickness(m)	77	4.65	38	4.63	27	4.67	20	4.55
	Al₂O₃ %		45.71		45.80		46.16		45.82
	SiO₂ %		2.03		2.12		1.96		2.07

N = number of bore holes, EV = expected values

Based on the data of the table above the deposit seems to be about 4 times over drilled.

3. Analyses

3.1 Sample preparation

Most of the analytical errors may derive from incorrect sample preparation. For taking a representative sample from bauxite the *Richards-Cherrchette's* formula is advised to follow:

$$Q = k \times d^2$$

where Q = the reliable weight of the sample crushed down for quartering in kg, d = diameter of the largest particles in mm and k= factor which is for bauxites 0.05. For example 1 kg of sample can be taken from a bigger quantity provided the maximum grain size is less than 4.47mm. For chemical analyses generally samples of 100 grams are taken and sent to the labs. In this case the gradual pulverisation (and gradual quartering) should be done to achieve particles of maximum 1.41mm. In practice sieves of -14 tyler mesh (1.17mm) are used.

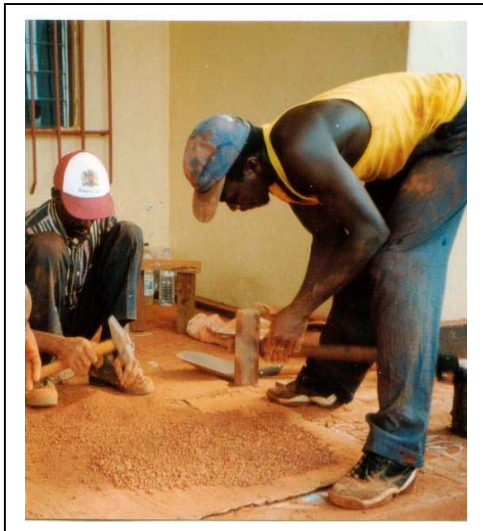

The laboratories should have to crush down the whole 100 grams sample to 100 micron. Most of the errors comes when not the whole volume of the sample is screened through and the very hard (iron rich – alumina poor) particles remained uncrushed. In this cases higher alumina concentration will be analysed than is in the original sample.

**Sample preparation of Sinthourou
(Guinea) bauxite
Photo 9.**

3.2. Analytical methods

- (1) Wet, traditional chemical analysis is still widely used. The alumina is determined directly (most frequently by complexometric method) or indirectly (four main components analysed, results added and alumina calculated by difference from 99% or 99.5%). Permitted error in alumina is +/- 1 % abs. and for silica 0.5% abs.
- (2) Bomb digestion for alumina soluble at different temperatures (e.g. 145⁰C and 235⁰C (this method applied at the Sangaredi mine – Guinea)
- (3) Atomic absorption spectrometry (ICP)
- (4) X-ray fluorescence spectrometry (XRF)
- (5) Neutron activation analyses (Tatar method)

It is beyond doubt that the most reliable method is still the traditional chemical analysis. Among the rapid analyses, both the ICP and XRF may satisfy the demand of the exploration but for this purpose carefully prepared standards and calibration are needed to be applied and prepared directly for the investigated deposit because the high mineralogical effects, including variations in crystallinity may result in significant errors (G. BARDOSSY – G. J.J. ALEVA, 1990).

3.3. Frequency of analyses

In bauxite usually each 1m interval of drilling or pitting is analysed which is correct. In some cases at the contacts of between the ore and overburden and bedrock sampling in 0.5m interval may be needed.

It is firmly believed by the author that, in general, too many superfluous analyses are made. No five component analyses are needed in the detailed and mine development explorations for every sample. The average titania and iron contents can be calculated from the averages obtained from the preliminary explorations and they must be sufficient to calculate with their average.

What is important for the alumina industry is the exact determination of the total or available alumina and the total or reactive silica contents in the detailed and mine development stages of the exploration. For that reason the wide application of the Bayer bomb digestion method is recommended in the detailed and mine development explorations more than it is now used all over the world. It is also worth mentioning that the cost of a five component analyses more or less equals the cost of a bomb digestion, but plenty of time can be spared by much lesser data processing. Of course, there are several cases when the concentration of the other impurities such as C^{org} , ΣS , and carbonates are also important in mining block units or even in daily production which must be analysed regularly.

4. Mineralogy

It is a general rule, all over the world, that the mineralogical make up of the bauxites is much less investigated than necessary. In many cases the mineralogical make up is known by several composite samples or by representative samples only collected for technological purposes which do not provide always adequate information for the alumina industry. It may happen that bauxites of quasi same chemical compositions determined by traditional five component analyses may be significantly different in their mineralogical make up: such as at the Worsley mine where both the greenstone rocks and the granite have weathered to bauxite and the difference of parent rock controls the gangue mineralogy rather than the alumina or reactive silica level (R.A. HINDE AND D.M. MARANTELLI, 1992). Mineralogy may be variable in karst bauxite: mono - tri-hydrate, hematite - goethite ratios are varying between extreme values (both laterally and vertically) in the same ore grade of the same ore body (KOMLÓSSY, GY. 1969). In the Jamaican bauxite the mono - tri-hydrate ratio depends on the actual topographic level (HILL, V. G. 1955).

An alumina refinery can be operated well if it is fed by bauxite which is, as much as possible, steady both in its chemical and mineralogical composition. For that reason the bauxite deposits must be explored adequately also from the mineralogical point of view.

It is obvious that less mineralogical tests are sufficient if the bauxite has a simple “homogenous” mineralogy :

- alumina minerals are either in tri- or in mono-hydrates,
- iron minerals are mainly in hematite or the hematite/goethite ratio is more or less constant,
- the alumina bound in iron minerals is negligible,

- the silica bound in quartz and clay mineral(s) can be foreseen on the basis of chemical analyses.

Even in these cases the mineralogy of bauxite deposit(s) must be thoroughly clarified. The horizontal and vertical distribution of the main mineralogical components must be known. The phenomena of the *mineral individualism*: the grade of crystallinity and regularity of the crystal structure (size of crystals) along with their distribution must also be considered (G. BÁRDOSSY, K. JÓNÁS, A. IMRE, K. SOLYMÁR 1997)

In case of a large deposit (reserves >50 mil. tons) 10-20 whole profiles are recommended to be analysed for each 1m interval. Thus one profile section would represent 2.5 – 5.0 mil. tons of ore. The sampling profiles (bore holes, pits) must be horizontally evenly distributed. If the deposit has been developed on different parent rocks it has also to be taken into consideration and sampling made proportionally. In case of medium or small sized deposits more samples are advised to take (one profile for each 1 – 2.5 mil. tons).

It may occur that a bauxite deposit has mono-hydrate rich lenses (boehmite > 10%) inside the tri-hydrate ore body representing significant and valuable tonnage. Provided selective mining is economical, the “mono-bauxite” should be separately stored and sold on the market to feed a high temperature plant (*Sangaredi*). In such a case there is no other solution but – for establishing the mono-hydrate content - the regular bomb digestion analyses for soluble alumina at different temperatures

When the mineralogical make up of the bauxite is even more complex and alumina and iron may also be bound in chamosite and iron in pyrite and/or siderite, mineralogical tests (comprising the whole industrial grade section) and recommended to be performed for each 2.0 – 2.5 mil. tons of bauxite. Otherwise no reliable representative sample can be taken for technological tests.

5. Grade control: mine development exploration and production

The planning and development of the mine are based largely on grade control with due consideration being given to the physical and operational variables.

The aim of the grade control is to provide data for making short term plans (shift, daily, weekly and monthly basis) making possible extraction of uniform grade bauxite shipped to the plant. Mining companies have to pay penalty if the grade drops below the contracted values, the premium paid for better quality shipments hardly compensates for the penalty loss. For this purpose tonnage, grade (and contaminants) have to be determined for each mining unit more precisely than by the detailed exploration.

In order to avoid fluctuations in grade and contaminants, stockpiles for blending purposes are set up for higher and lower grade products. Blending made from these stockpiles can proportionally satisfy the demand of the plant. Operating a blending system increases the mining cost about by 4% - 6% because of the increased capital expenditures for stockpile(s) maintaining.

When bauxite mining is well prepared by mine development exploration and the ore body is homogenous enough, no blending is needed. In this case the operation can be managed according to the consumer's demand directly by proportional extraction from different mining faces.

In practice, in some open pits, when the overburden have been stripped off and the bauxite prepared for mining, the ore is drilled in 25m x 25m or in 10m x 10m grid in each bench. In several cases the variances may be so high that samples are necessary to be taken also from the blast holes (say 6m x 6m). In open pits the bauxite is often extracted in benches varying between 2m and 3m in thickness (depending on the total thickness of the ore to be mined out). The depth of the grade control drilling is determined by the thickness of the benches and samples are analysed for the whole thickness.

At the *Trombetas* mine (Brazil) channel samples (20cm x 10cm) were taken from both sides of the walls of the formerly excavated stripes and bauxite recovery was also checked in laboratory. If necessary the grade of bauxite production is to be checked continuously. Grade control of the ore mining should be carried out on each shift based on the analyses of the ore discharged from the haulage system. Sample cuts are taken regularly: and periodically from the conveyor belts (e.g. in every 15 – 30 minutes) or from each truck and composite samples analysed for (available) alumina and (reactive)silica. The results are reported to the geological or mining department where adjustments are made to the mining programme for the following day(s) as required (as at Worsley in Australia, Sangaredi, Kindia in Guinea, Accaribo in Surinam, Los Pijiguaos in Venezuela, etc.).

6. Resource estimate – reserve calculation and their economic impact

6.1. Methods

There are several methods developed for resource estimate and reserve calculation. More and more sophisticated procedures have been introduced during the past 20 years. Application of computer aided *geostatistical methods*, *geo-mathematical models*, and *krieking* gave a remarkable impetus to the development.

It is common in any bauxite deposit that the range of variances are different with different parameters (see Paragraph 2.2.2.). In the case of karst bauxites, when the bedrock is highly karstified, the variance is the greatest in thickness, the second in rank is the silica and the third is the alumina.

In the case of laterite bauxites, in general, the variance in thickness is much less than that of the other parameters in a distance of 50m -100m. It may occur that in a short distance the surface of the bedrock (non-commercial grade bauxite) forms a very undulating surface in about ten meters distance with an amplitude of 1-2 metres, see **Photo 10**. It makes the mining difficult and results in significant mining loss or dilution or both, (e.g. Accaribo mine in Surinam, Kindia in Guinea, etc.). In other cases the bedrock surface is relatively smooth such as in case of Deccan bauxite deposits (India).

Undulating bedrock surface – Kindia in Guinea

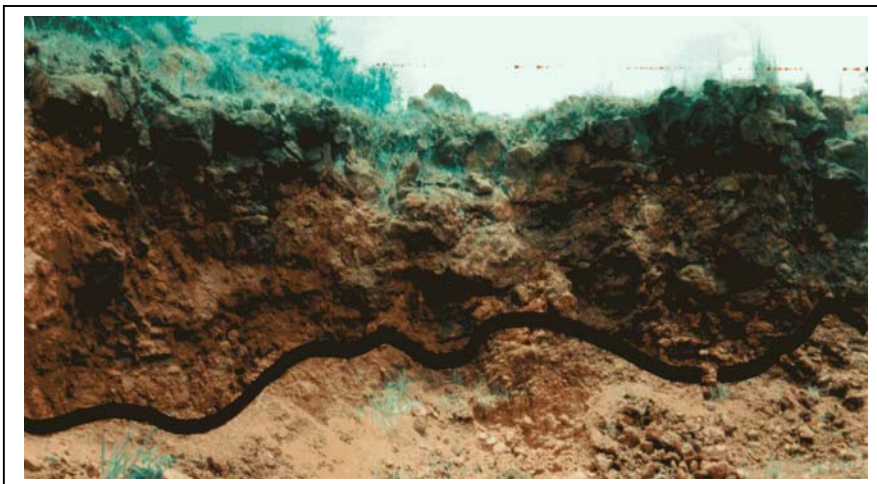
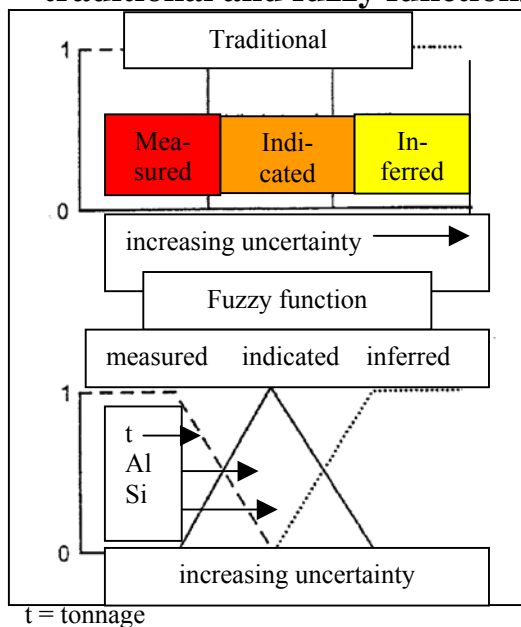

Photo 10.

Unfortunately the fact that the error in different parameters over the same distance may be different. It is often not indicated in the reserve categorisation which is dedicated to express the uncertainty of the exploration. It may happen that the reserves are explored in measured (B, or proved category) for tonnage while for alumina and silica it is in only in indicated (C_1 , possible) category. For solving this contradiction the *fuzzy method* was proposed recently by G. BÁRDOSSY (2002) to be applied in the bauxite reserve calculation. As a matter of fact the method seems to be appropriate to express the possible different uncertainty in the different basic parameters (alumina, silica, thickness, etc). **Fig. 20.**

Comparison of the uncertainties in traditional and fuzzy functions



Giving an overview on different methods is out of the scope of this study but three important aspects are emphasised:

- (1) Computer must be fed only reliable and consistent data (the errors of the input data should be calculated or at least estimated (BÁRDOSSY-ÁRKAY-FODOR 2001).
- (2) Method must be fitted to the deposit

Compiled after G. BÁRDOSSY 2003

Fig 20.

Notes on above:

(1). This rule is absolutely obvious, nevertheless, the Author had to face many times that it had not been followed and the computer was fed incorrect data. In case of a South American laterite deposit about 3 % of total silica was revealed by drilling. Mining verified bauxite of some 5 % of silica. The difference is too much to be due to dilution. Two absolute percent of silica in the alumina plant of 1 mil. tpa set up for this deposit resulted in ten million USD surplus in expenses per year. Consequently during the drilling some kind of “ore beneficiation” went on resulting much better quality bauxite (probably very fine powder of kaolinite was flushed out). The bias was decided to be eliminated by applying a complicated geo-mathematical model. The operating mine was stopped and a new one opened for a better bauxite. It turned out that the new deposit was not better either, because it had been drilled with the same method. In such cases not a geo-mathematical model but application of a reliable drilling technique should have been introduced.

(2.) Figure of the tonnage and grade of the bauxite may also depend on the method used in calculation. It is shown in the **Table 3.**

Table 3

Reserve assessment comparison applying different methods in a test area

	R. polygonal			D. Kriged			Current polygonal		
	million tonnes	avAl ₂ O ₃ %	rSiO ₂ %	million tonnes	avAl ₂ O ₃ %	rSiO ₂ %	million tonnes	av Al ₂ O ₃ %	rSiO ₂ %
raw data	63	31.2	1.3	94	30.0	1.4	78	29.9	1.3
expected mining	54	31.2	1.3	63	29.4	1.6	78	30.8	1.6

All methods used the same raw data of the detailed exploration. Current polygonal method was accepted and applied when after the mine development explorations verified its correctness for tonnage, however the bias was bigger (but acceptable) in grade. For grade the R. polygonal method was proved to be perfect.

6.2. Tonnage versus grade reserve calculation – maximum profit

6.2.1. Bauxite qualifications

In many cases cut-off values – standards - are set up for reserve/resource calculation without analysing their effect on the tonnage and grade of the deposit(s), ie. economical considerations are neglected. Sometimes **old standards are used** established in the early 20th century in the Soviet Union and never investigated how far it satisfies the interest of the economy. Such a cut-off criteria was used also in the socialist countries called “silica modulus” (M_{Si}). Criteria for the industrial grade ore, according to this pattern is as follows:

$$M_{Si} \text{ Al}_2\text{O}_3 \text{ \%}/\text{SiO}_2 \text{ \%} \geq 2.6, \text{ Al}_2\text{O}_3 \text{ \%} \geq 40$$

For bauxite deposits of Russia, such as *Timan* and *Severuralsk*, these figures are still applied. Beyond the fact that these formulas has no technical, scientific, economical reasons huge bauxite deposits would have been excluded from the economic grade ore (such as the Australian deposits referred above) on one hand and on the other one huge deposits becomes uneconomic in the free market by involving low grade bauxite into the reserves (e.g. Timan). This system itself does not function. If the numeric values are increased, module from 2.6 to 10 and the minimum Al₂O₃ from 40% to 50% (as it was done at the *Kindia* deposit – Guinea) it may happen that bauxite is involved into the reserves containing 51 % of alumina and of 5% silica and bauxite excluded from the reserves represented by 49% alumina and 3% of silica which is a nonsense. It is to be mentioned that Russian geologists (Y. LISSOV – V. ZMEEV – 1997) themselves have realised its indefensibility and for a *Debele* block tonnage versus grade calculation was made using Ar cut off value: Al₂O₃ %– SiO₂%. Unfortunately, the total reserves were not re-calculated with this formula.

The qualification of the bauxite has to express its value which has to be in harmony with the processing cost of the alumina, that is the available alumina content (ABEA) which is the amount of alumina extractable in the plant in case of low temperature procedure (ca 145⁰ C):
 ABEA= Al₂O₃%total – (x) SiO₂ reactive, in case of high temperature procedure (≥ 235⁰ C)
 Al₂O₃ % total – (x)² SiO₂ % total.

² Value of (x) is determined by the actual technological conditions varying between 1 and 2.

6.2.2. Genetical and geochemical considerations: theoretical basis of the tonnage vs. grade calculation.

(1) Laterite bauxite

The most important laterite bauxite profiles have been developed by an “in situ” and direct process. Lateritisation and bauxitisation, under favourable conditions, are simultaneous processes commenced at the beginning of the tropical weathering of the parent rock in the oscillation zone of the ground water table. This phenomenon is proven by the young (Quaternary – Sub-Recent) laterite profiles where in the soft lateritic clay gibbsitic nodules can be found formed, at least in majority, directly from feldspars. Under favourable condition tropical weathering is an incredibly fast process. In Mexico (Tenejapa – Chiapas State) lateritic soil developed on the surface of Pleistocene andesite tuff. Because of the high porosity of the rock the process has gone ahead very quickly, see **Photo 11**. As the bauxitisation proceeds bauxite deposits develop, see **Fig.21**.

Lateritic soil with gibbsitic nodules and paleo-soil interbeddings

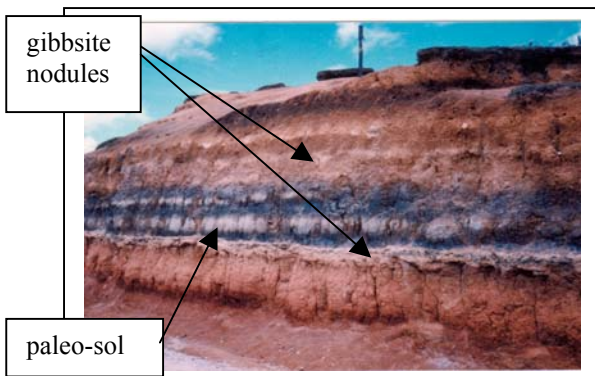
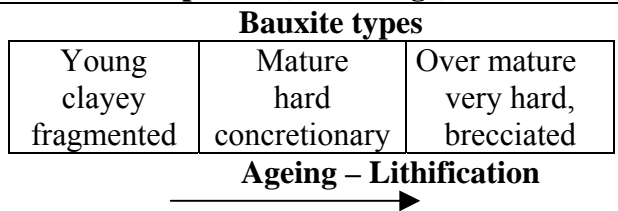
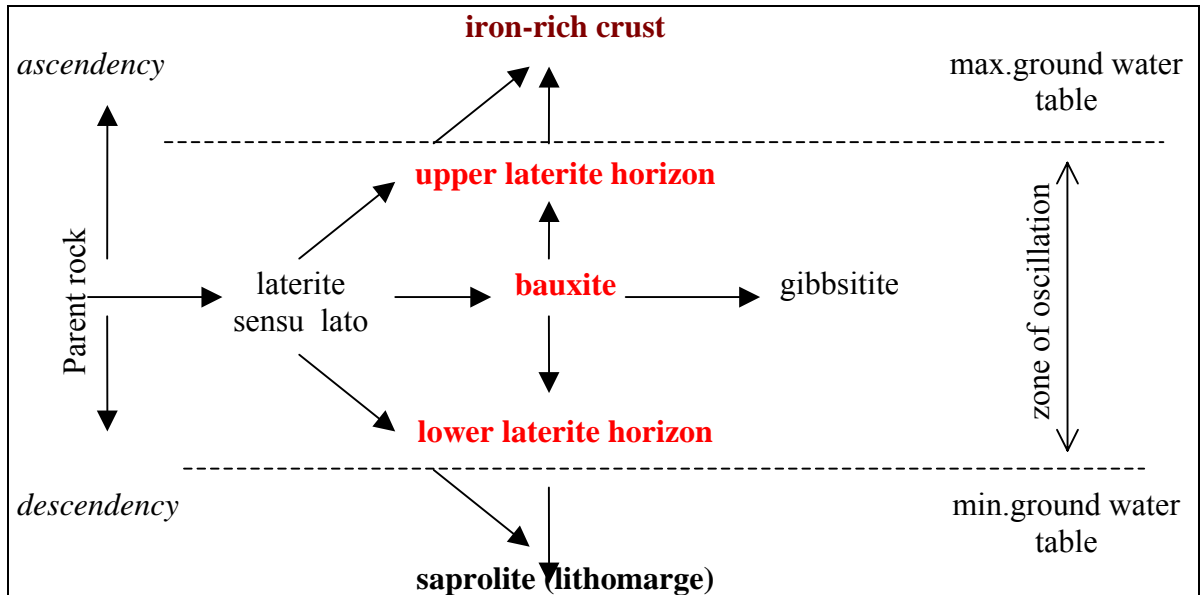

Photo 11.

Bauxite profile is the result of a chemical erosion in which the mobile elements (alkalis and earth alkalis) leached and the less mobile silica partially dissolved and depleted. At the same time the immobile elements are enriched, resulting in a sandwich structure. (**Fig. 22**) Iron is also a mobile element but only in a very short distance and its secondary accumulation is limited. Leaching is the most effective in the zone of oscillation.

Relative concentration of the alumina is going on up to a maximum rate permitted by the iron. As the system can not get rid of the iron therefore the iron content of the parent rock restricts within the weathered profile. The alumina accumulation: $\text{Al}_2\text{O}_3\%$ + $\text{Fe}_2\text{O}_3\%$ tends to be a quasi constant value: 65%-67%, provided the free silica content is negligible. (theoretical Al_2O_3 content of the pure gibbsite is 66%). The degree of the bauxitisation, as a consequence, is limited by the iron content of the system. Laterite bauxite deposits, based on the degree of the bauxitisation - which is manifested in their lithological and geochemical features - have been grouped into three main types such as *young*, *matured* and *overmatured* deposits, see **Fig. 21**. (G. KOMLÓSSY 1973, 1997). In all of these types vertical zoning is common with a zone of gradual transition: the best quality bauxite is bordered by lower grade ore horizons both upward and downward, making a selection possible by cutting off gradually the upper and lower zones from the reserves. In older bauxite a thinner transition zone is typical.

Lateritisation - bauxitisation



G. KOMLÓSSY 1997

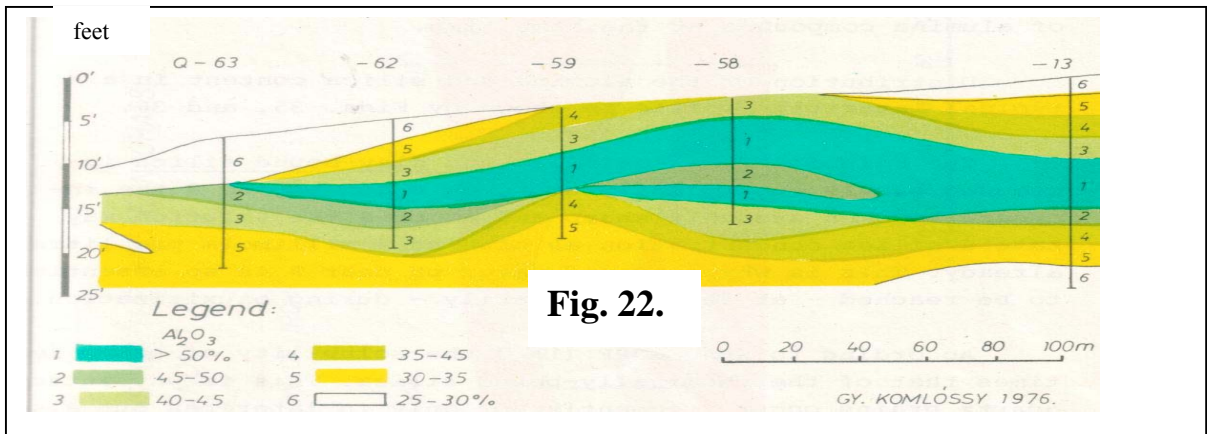

G. KOMLÓSSY: 1976

The three main types of laterite bauxites are as follows

- (a) Young soft (clayey) bauxite which is sandy, pseudo-fragmented, containing gibbsite or gibbsitic nodules, sands, angular bauxite “fragments” in bauxitic clay: Mexico, Bao Lok (Vietnam), Lichenya Plateau (Malawi), Trombetas (Brazil, etc). Lithification has only been commenced. Geochemical features are:
 - strong negative correlation between the Al and Si,
 - strong positive correlation between the total and reactive Si,
 - negative correlation between the Al and Fe may exist.
- (b) Matured (hard, pisolitic, pseudo-brecciated) bauxite such as Ghandamardan, Panchpatmali in India, Los Pijiguaos in Venezuela, etc. Geochemical features are::

- negative correlation between the Al and Si still exists, tightness of correlation is: around 0.5 – 0.6,
- positive correlation between the reactive and non-reactive silica,
- strong negative correlation between the Al and Fe, tightness of this correlation is >0.8

(c) Over-mature: characterised by white bauxite layers/lenses which consist almost entirely of gibbsite: Sangaredi in Guinea, Betul – Goa, Deccan bauxites in India, Az Zabirah in Saudi Arabia. See **Photo 12** Geochemistry:

- the negative correlation between the Al and the Si is almost negligible. In the white (Fe-poor) bauxite the correlation may even turn into a positive one because depletion of the iron provokes relative enrichment of the both elements,
- the negative correlation between the Al and Fe is very strong.

Bauxitisation is completed in the nature when change in $\text{Al}_2\text{O}_3\%$ (abs.) is accompanied by no more than 0.5% (abs.) change in SiO_2 .

Betul mine – Goa - India

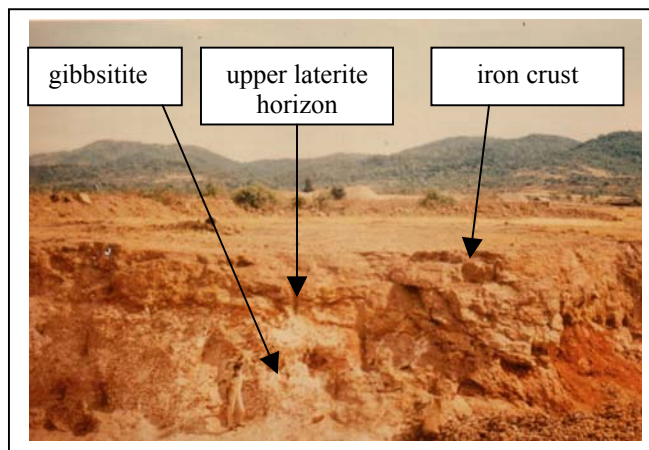

Photo 12.

(2). Karst bauxite

The sandwich structure is typical here also, because during the culmination of the ore forming, better quality bauxite accumulated on the karst surface where the bauxitisation might have proceeded in situ. The result is the same as in the laterite sections, the geochemical structure of the ore body permits cut off-s to be made at different levels.

6.2.3. Tonnage versus grade reserve calculation

In order to satisfy the demand of the permanently changing economic conditions the **geologist has to offer options for the decision makers** to decide which part of the bauxite body should be extracted, i.e. what type of bauxite should be regarded as industrial grade ore..

Let us investigate how the tonnage changes in function of grade in several bauxite deposits.

Tonnage versus grade reserves

Lichenya – Malawi (young bauxite)

Deccan (mature-overmature) bauxite

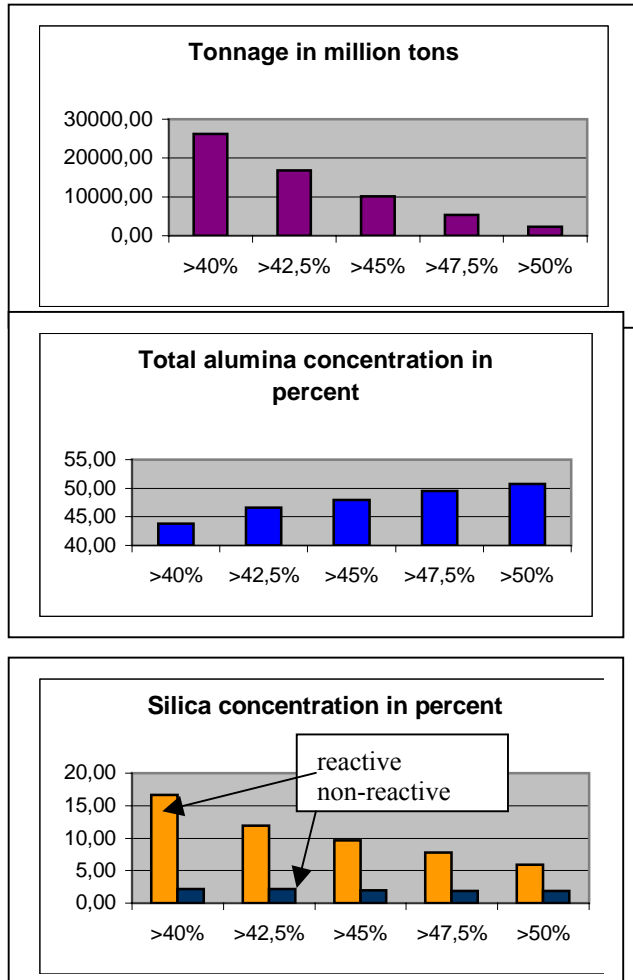

Fig. 23.

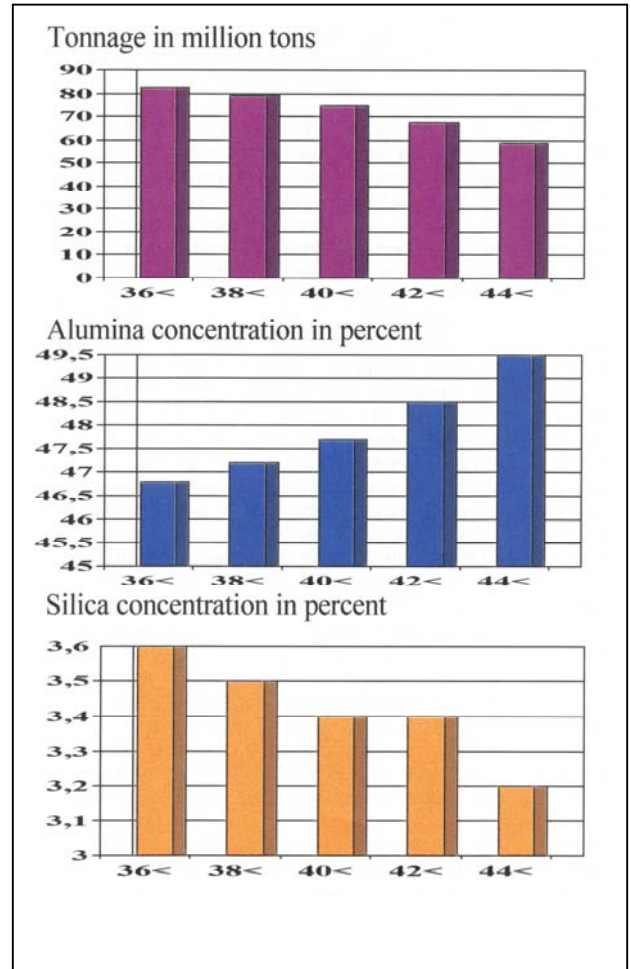

Fig. 24.

Tonnage versus grade reserves of a mature – over mature deposit Kindia – Guinea

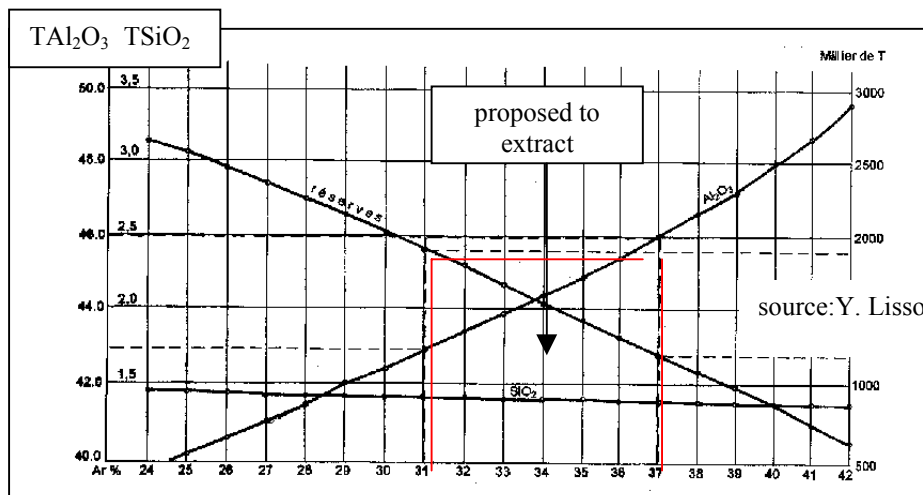

Fig. 25

source: Y. Lissov – V. Zmeev 1997

6.2.4. Economic aspects

Figures of 23., 24., and 25. show that the reactive silica content does not drop significantly by the increasing average alumina content.

6.2.4. Specific bauxite consumption and operating cost calculation (D. DONALDSON 2003)

- (1) The usage of the bauxite can easily deduced from the available alumina content. First, the overall recovery of the bauxite available alumina in a refinery will be close to 95 % and the purity of the product close to 98.8 %.

$$(1) \times (0.988 = \text{dry tons bauxite})$$

Therefore: bauxite usage = (TAA) (0.95)ton product alumina

$$\frac{(1)(0.988)}{(0.95)}$$

For 36% TAA bauxite usage: $(0.36)(0.95) = 2.89 \text{ t bx/t al.}$

Total available or recoverable alumina can be obtained by laboratory digest procedure. This measures the amount of the alumina put into solution by attacking the bauxite with hot caustic soda (an empirical test): consequently, other reactions have already occurred in the laboratory digest, such as the reaction with silica. The laboratory result (TAA) is assumed to be the available or recoverable alumina in the bauxite sample. Total chemical alumina (TCA) is the actual aluminium metal content in the bauxite built in minerals such as Al oxi-hydroxides, Al hydroxides, iron minerals (alumo-goethites), clay, and phosphates. This is the value used in geological surveys. TAA can sometimes be estimated fairly close by subtracting the alumina in the clay equivalent of TSiO_2 or, perhaps a factor times this value if the quartz content is significant.

Mono-hydrate bauxite may have a lower recovery (93% – 94 %) because the mono-hydrate alumina may not be attacked by caustic soda as with tri-hydrate alumina.

The operating cost, excluding the bauxite supply price to the plant and the bauxite silica content, will change only slightly with bauxite usage. A lower TAA will mean more bauxite to be conveyed and ground and more mud will be washed and pumped to disposal. Process investment cost is an other question.

- (2) Attacked silica (ASiO_2) is the silica that is attacked by caustic in the digester. 100% of the clay silica or reactive silica (RSiO_2) will be attacked. The other silica in the bauxite is quartz. In a tri-hydrate digest (e.g. $< 160^\circ\text{C}$ digest) there is essentially 0% attack of quartz silica. In a mono-hydrate digest ($\sim 250^\circ\text{C}$ digest) the amount of the quartz will depend on the time the bauxite slurry is above 160°C (the higher temperature the higher the rate of attack) and on the particle size of the quartz (the smaller particle the higher the rate). However, for estimating purposes 50 % - 60% quartz is attacked in high temperature digest.

Attacked silica (i.e. clay silica + attacked quartz silica) consumes about 1.18 tons of caustic soda: Therefore:

$$\text{Bauxite usage } (\% \text{RSiO}_2 + \% \text{ Quartz attack} \times \% \text{QSiO}_2) \text{ 1.18}$$

Example: 2.2 ton bx/ton alumina with 6% TSiO_2 and 4 % RSiO_2

Tri-hydrate digest caustic soda consumption: $(2.2)(0.04)(1.18) = \dots\dots\dots 0.104 \text{ t/t}$
 Mono-hydrate digest caustic soda consumption $(2.2)(0.04 + 0.5 \times 0.02)(1.18) = 0.130 \text{ t/t}$

For total caustic soda consumption about 0.025 kg must be added for other process losses per ton of alumina product. For actual caustic (NaOH) to achieve caustic soda must be multiplied by 0.755 ($\text{NaOH}/\text{Na}_2\text{CO}_3 = 80/106 = 0.755$).

6.2.5. Specific bauxite consumption and caustic soda price in the function of bauxite quality

Following the principles given above, the results for the Deccan bauxite are summarised in **Figs. 26.** and **27.** The difference in silica concentration between the highest and the lowest bauxite grades is 0.4 abs. %, but because of the high caustic soda price this difference results in about 5 USD/ton alumina. The profit can also be gained by increasing available alumina content, that is, from the decreasing specific bauxite consumption which is much as 2 USD/ton alumina. In our concept the increasing mining costs are compensated by the lower transport cost.

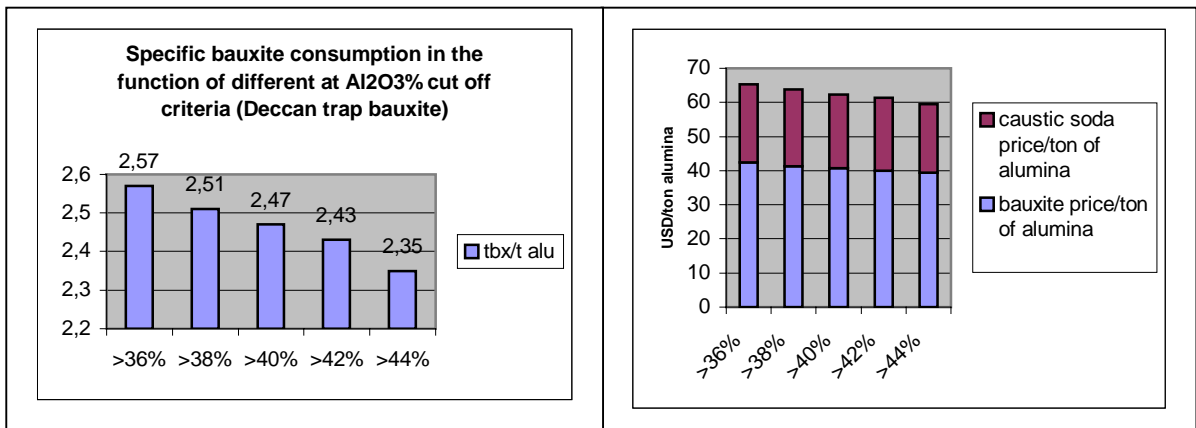
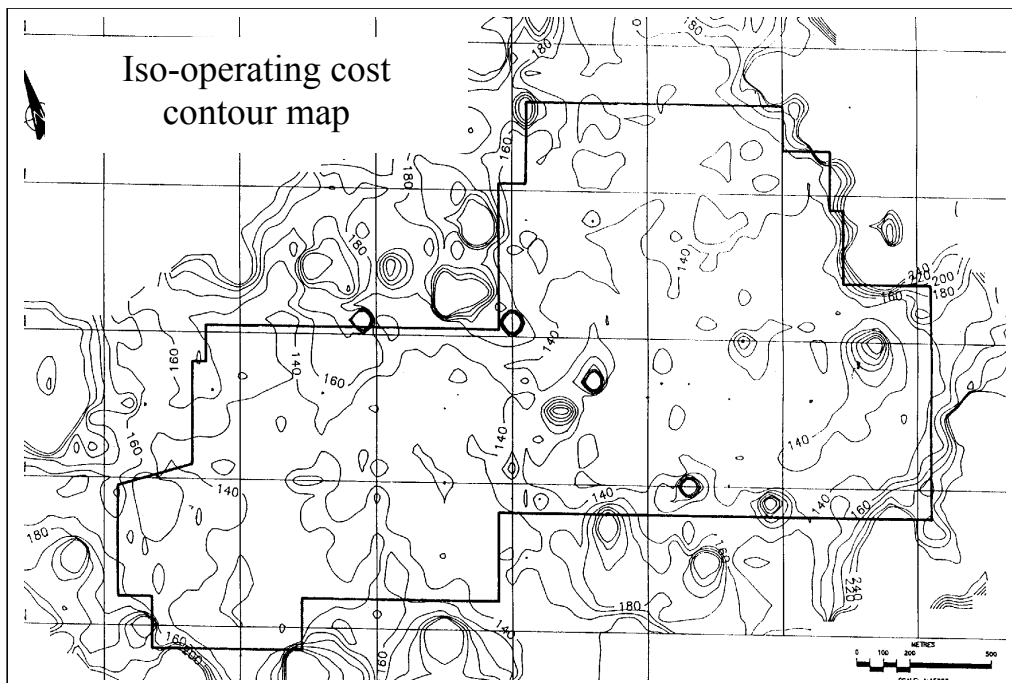

Fig 26

Fig 27

In order to demonstrate the expected operating costs of the alumina - in the function of the bauxite grade - an “Iso-operating cost contour map” was plotted for a Suriname bauxite deposit, in the early nineties, making it possible to follow the changing economic conditions in the mining. see **Fig. 28.** Such a map may be very useful in mine production management.



6.2.6. Economic aspects

Fig. 28.

Let us investigate how the value of the bauxite reserves changes in the function of different cut-off grade ores in the case of the Deccan bauxite (**Fig. 24**). The following conditions are supposed:

- High temperature refinery (because of the 5-6 % of mono content) of 800.000 tpa capacity, 90% of alumina recovery
- Bauxite price at plant 16.48 USD/ton (dry basis)
- Total silica = reactive silica
- Caustic soda price 217USD/ton
- Cumulative discounted annual “extra profit”: discount rate 10%, discount factor 1.10

Table 4

Cut off Al ₂ O ₃ %	profit on quality million USD	life time of mine year	total extra profit in million USD
≥36	0	40.1	0
≥38	14.04	39.4	550
≥40	22.92	37.6	861
≥42	29.60	35.0	1.036
≥44	46.68	31.0	1.447

Calculating bauxite reserves higher than ≥44% of Al₂O₃ the reserves drop in tonnage in such a measure that the total revenue decreases by 1,447 million USD and quantity drop from 80 million to 59 million tons of reserves³.

In consequence:

- the best grade bauxite offers the maximum profit, provided sufficient bauxite is available, if not
- exploration of new deposits (provided the tonnage does not meet the demand of the plant) should be shared in priority, bauxite exploration cost is negligible (0.0725 %) when compared with alumina production cost (see Paragraph 2.1.4).

³ In this figure two items are not taken into account, namely, the increasing mining cost/ton of bauxite from the higher stripping ratio which increases from 0.7 to 1.17 and transport cost which drops from US 40 million/a to US 37 million/a.

6.2.7. Optimum cut-off model

In some cases the possibility of discovering new deposits is limited. When a given quantity of resources must be economised the following concept is proposed (B. FODOR., 1999):

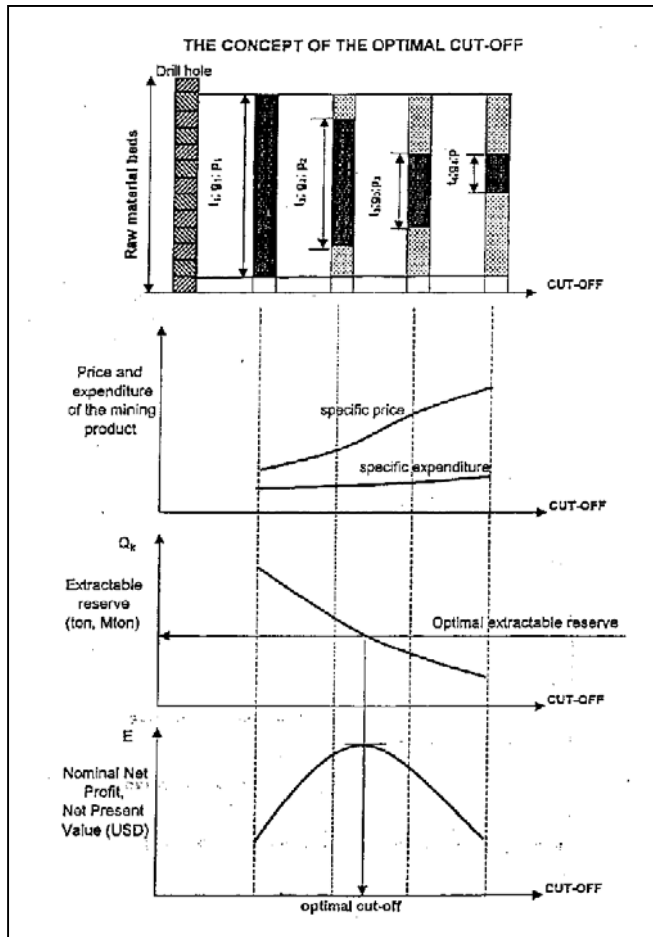

Fig. 29.

6.2.8. Economic block modelling

When the concept of the “industrial grade ore” has been established and reserve calculation made applying inverse distant square method, the following main parameters are recommended to calculate for each mining block unit - in order to evaluate the bauxite pit limits with changing economic factors - as it was introduced for a Suriname deposit:

- Available alumina content (diluted) of the block,
- Reactive silica content (diluted) of the block,
- Bauxite tonnage of the block,
- Overburden to be stripped to expose the industrial grade ore,
- Cost of stripping, blasting and haulage of the block,

A simplified outline of the optimum cut off model (in case of “Fund” resource/reserve) for a single drill hole is shown in **Fig 29**. In this figure the grade of the upper and lower horizons gets lower which is common also in karst bauxites. The calculated thickness in meters (t_1, t_2, t_3, t_4), grade (g_1, g_2, g_3, g_4) and specific price of the mining product in USD/ton (p_1, p_2, p_3, p_4) of bauxite is in function of different cut off values.

Of course, because of the changing economic conditions, regular re-evaluation of the deposit is necessary for maintaining the maximum profit level continuously.

- Cost of overhead (fixed cost) must be borne from the revenue of the block,
- Refining cost of the block: caustic soda and energy prices,
- The unit price (revenue) provided by the refinery

7. Summary

Typical Exploration Programme

Flow sheet of an exploration program
proposed for a Deccan bauxite occurrences

A. First Stage: Reconnaissance

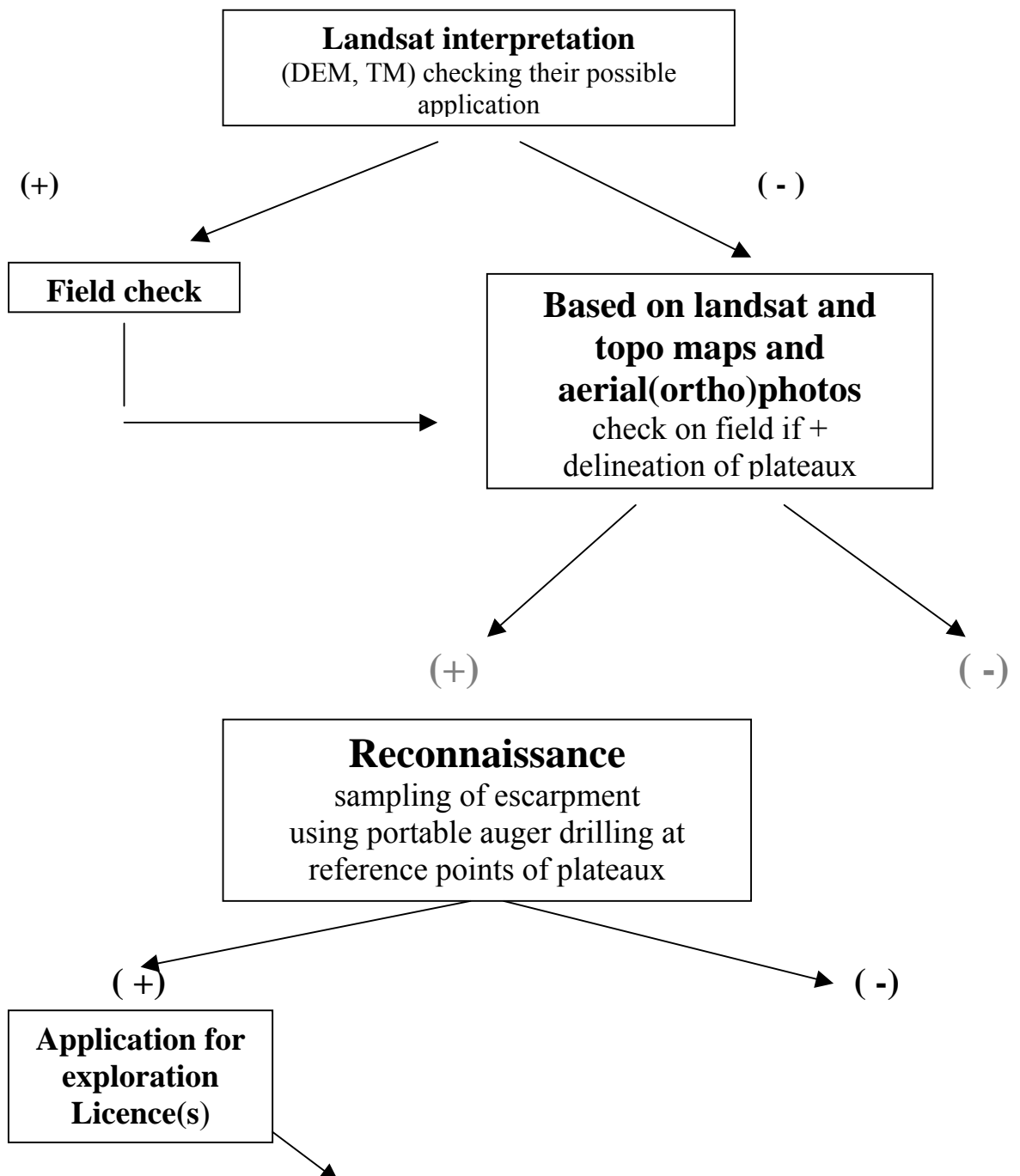

First selection
**based on: potential, accessibility,
 infrastructure, distance, mineability**

(of the deposits identified and selected at the end of the First Stage)

(1)Drilling/pitting in
400 m x 400m grid
 (2) **Beneficiation test:**
 determination of method, technology
 min. grain size and recovery
 (3) **Characteristic sample:**
 alumina technology, establishment of the
INDUSTRIAL GRADE ORE
 (4) **Resource estimate:**
 (inferred and indicated categories)
 (5). **Second selection:**
 priorities given to deposits in the function
 of grade, tonnage and transport distance

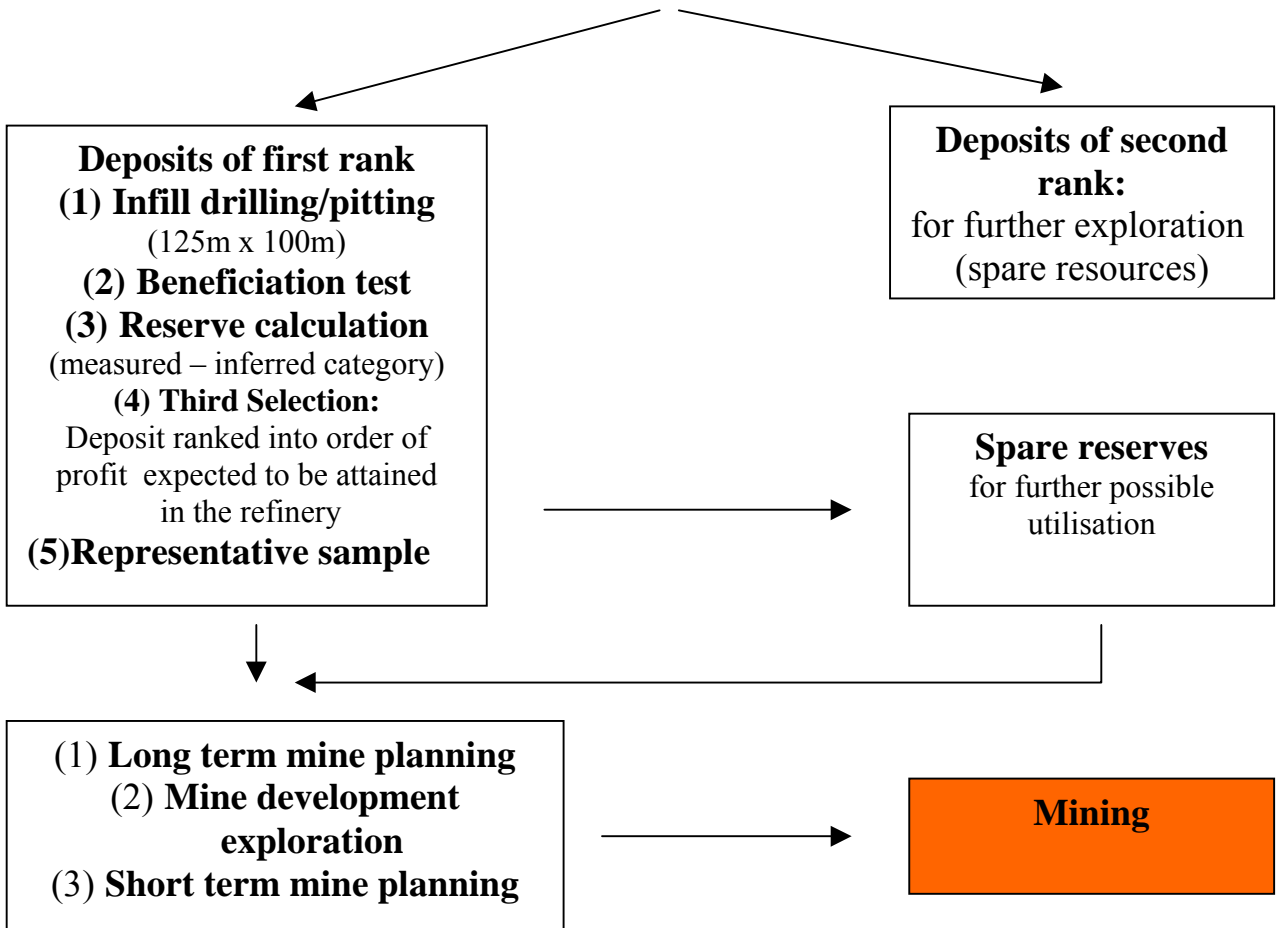

Conclusions

- (1) There is no use to spare money on the geological activities. Fast decisions – which may be essential in the economy – can only be made when they had reliably been prepared by geological reconnaissance, exploration and data evaluation.**
- (2) Landsat interpretation offers an excellent tool in finding new deposits and establishing the bauxite potential in a large area.**
- (3) Geological (mining) risks can considerably reduced by correctly made exploration and data evaluation, - For this reason, the best available drilling techniques must be applied which provide the most reliable data.**
- (4) In the data evaluation (reserve/resource calculation) consistent data must be processed, drilling/pitting grid should be established accordingly.**
- (5) Exploration techniques, drilling/pitting grid, reserve calculation and resource estimate must be fitted to the nature of the deposits. Even the best experiences, obtained at a bauxite occurrence, can be only carefully applied on an other (unknown) one. The different nature of the deposits (geology, petrography, mineralogy, etc) determines the exploration techniques and strategy.**
- (6) Tonnage vs. grade reserve calculation provides economical options by which the maximum profit can be established.**
- (7) The decision makers of the bauxite-alumina industry have to utilise the geological knowledge in a more extended manner than generally it has been done so far, because it may improve the economy of the bauxite-alumina industry.**
- (8) More effective contribution to the economy of the bauxite alumina-industry belongs to a geologist's responsibility.**

Selected references

- AUSTROPLAN AUSTRIAN ENGINEERING CO- VIENNA – AUSTRIA : Integrated exploitation and processing of Mulanje/Manica bauxite and establishment of alumina/aluminium industry in the SADCC region - 1990
- BÁRDOSSY, GY., – JÓNÁS, K., IMRE, A., SOLYMÁR, K.: Interrelation of bauxite texture, micromorphology, mineral individualism and heteromorphism. *Econ. Geol.* 1977
- BÁRDOSSY, GY.: – G.J.J. ALEVA: Lateritic bauxites – *Akad. Kiadó* – Budapest 1990
- BÁRDOSSY, GY.: A Földtani kutatás bizonytalanságai és kockázatai – új utak ezek megoldására (Geological uncertainties and risks – new ways for solving) – *Magyar Tudomány* 2002/9 Budapest.
- BÁRDOSSY, G.- ÁRKAI, P. – FODOR, J.: Application of the fuzzy set theory for the quantitative phase analysis of rocks by X-ray diffractometry (in Hungarian). *Földtani Közöny V. 131 pp331-341. Budapest 2002.*
- FODOR, B.: Bauxittelemek ásványvagyonának értékelése korszerű bányászati geometriai módszerrel – Egyet doktori értekezés (Evaluation of reserves of bauxite deposits with the aid of modern geometrical methods) – *Manuscript* Miskolc 1982.
- FODOR, B.: Practical application of the United Nation Framework classification of reserves/resources. *UN Economic and Social Council – Energy/1999/8*
- HAPPEL, U – HAUSBERG, J. - MAYER, E.M. – MARINO, N: The variation of the grade distribution in the Los Pijiguaos bauxite deposits, Venezuela: computer aided model . – *ICSOBA Travaux Vol 26 No 30.* – Athens. 1999
- HIERONIMUS, B.: Étude de l’altération des roches éruptives de l’ouest de Cameroun. Latéritisation, bauxitisation et evolution bauxitic – *These de doctorat d’état univ. Pierre et Marie Curie No 85-20* – 1985
- KOMLÓSSY, GY.: Minéralogie, et génétique de la bauxite du Vietnam N. *Acta Geol. Sci. Hung. Budapest, 1975.*
- KOMLÓSSY, GY – MINDSZENTY, A. – SZABÓ, E. – SZANTNER, F.: Principles and method of bauxite prospecting. *UNIDO – ALUTERV-FKI publication – 1979*
- KOMLÓSSY, GY.: Lateritic bauxite and iron ore formation in Goa – India. (in Hungarian) – *Földtani Szemle No. 9.* – 1976
- KOMLÓSSY, GY.: Geological background of bauxite forming (karst and laterite). – *ICSOBA Travaux Vol.24.* 1997 – Milan
- KOMLÓSSY, GY.: - SIKLÓSI, P.: - TÓTH, GY.: - CSILLAG, ZS.: Techno-economic study for the commercial extraction of alumina from bauxitic clays – Ostuacan – Chiapas, Mexico. - *UNIDO project No. UD/UC/Mex/86/203 – Mexici City – 1988.*
- KOMLÓSSY, GY. – UNGER, Z.: Application of Remote Sensing Techniques in Bauxite Resource Estimation. *ICSOBA Travaux Vol. 31.* – St Petersburg 2004.
- KOMLÓSSY, GY.: Report on the East Coast Bauxite Deposits and their Further Prospects Established by Landsat Interpretation. *Manuscript.* Budapest 2006
- LISOV, J. – ZMEEV, V.: Rapport de la prospection d’exploitation du gite bauxitique de SANKAREN gisement – Debele – Guinée – *Manuscript* Conakry 1995
- MAKSTENEK, I.O. – MAMEDOV, V.I. PORFINOV V.S. – TEREKOV, G.I.: Rapport portant sur les résultats de la prospection détaillée du gisement bauxitique de Debele – Guinée – *Manuscript* . Conakry 1970

- MAMEDOV, V. I. – LISSOV, J. ROUDASHEVSKI, L.: Rapport sur la résultats de l'étude de la composition chimique et minéralogique de la propriétés technologique des bauxites de ghisemments Debele et Balandougou - *Manuscript* . Conakry 1988
- MENENDEZ, A. – SARMENTO, A.: Geology of the Los Pijiguaos bauxite deposits . Venezuela, *in Jacob jr. L ed., Bauxite Proc.. 1984 Bauxite Symposium, Los Angeles USA A.I.M.E.*, New York, pp 387-407 – 1984

**A Geologist's Responsibilities
in the
Aluminium Industry**

G. Komlóssy
Budapest – Hungary
2006